

ATF 70G-4 | MAIN BOOM 52.1 m

70 METRISCHE TONNEN TRAGLAST / 70 METRIC TON CAPACITY

ALL TERRAIN CRANE



2 MOTOREN
ENGINES

Maße (mm)
 Dimensions (mm)
 Dimensiones (mm)

445/95 R 25
 (16.00 R 25)

DIN/ISO/EN

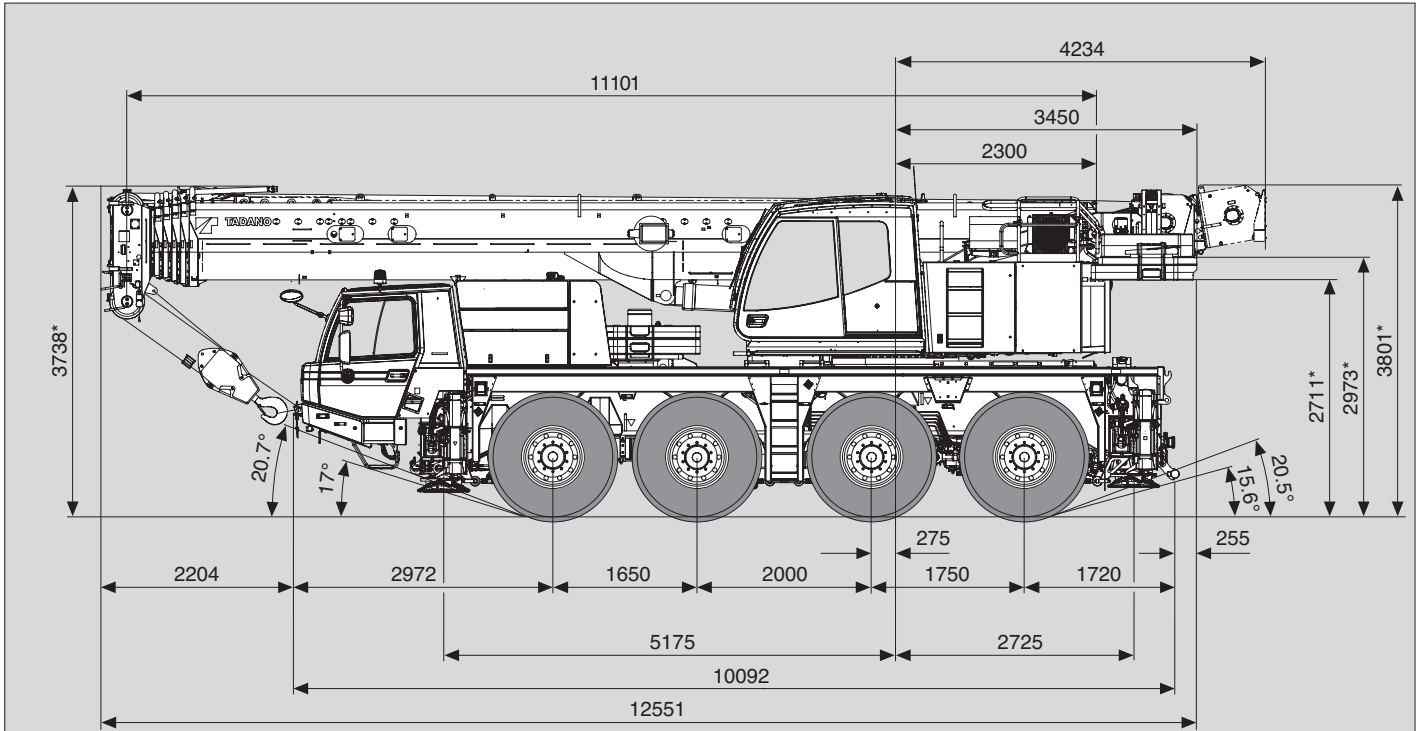

* ± 100

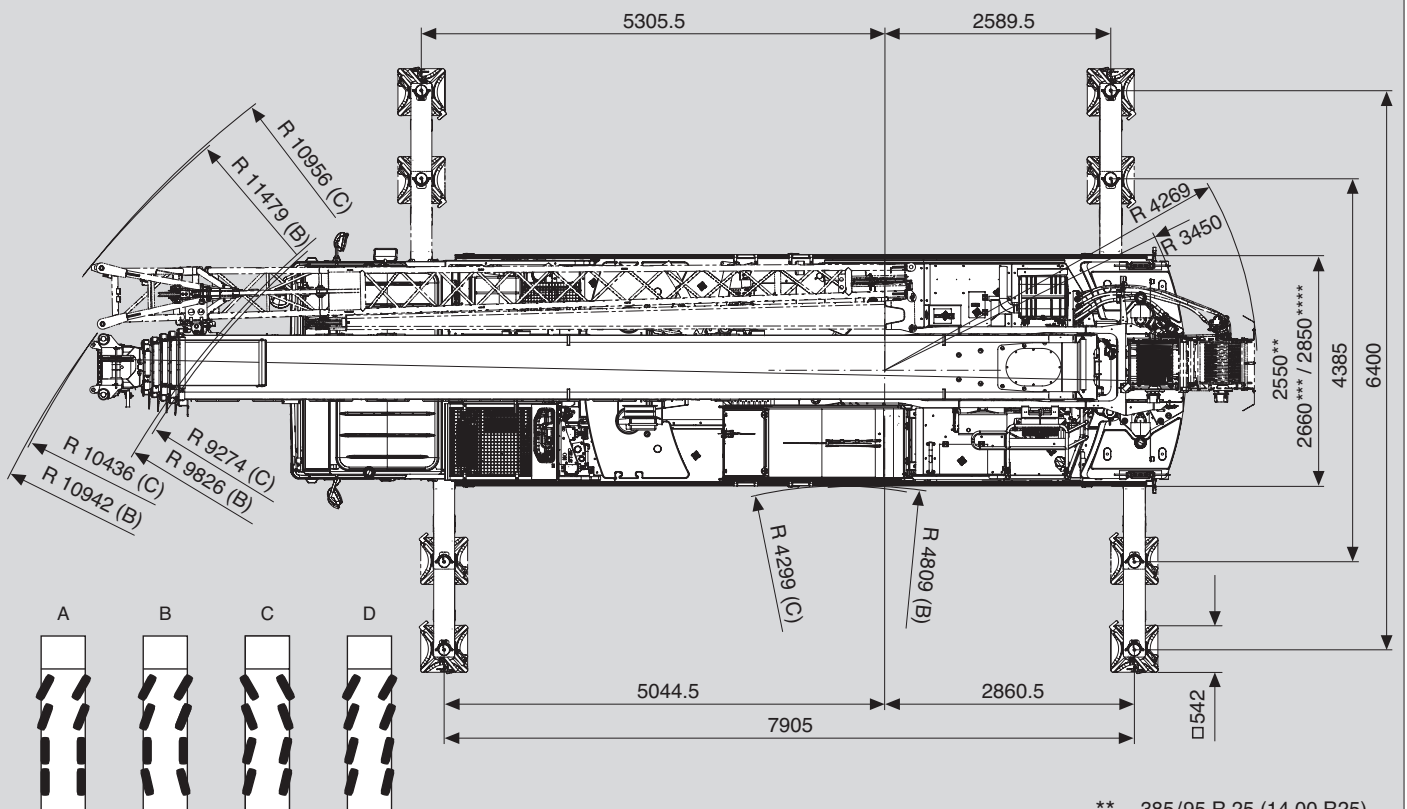

v > 25 km/h v < 25 km/h

** 385/95 R 25 (14.00 R25)
 *** 445/95 R 25 (16.00 R25)
 **** 525/80 R 25 (20.5 R25)

Gewichte / Geschwindigkeiten
Weights / Working speeds
Poids / Vitesses
Pesos / Velocidades de trabajo

	Achse / Axle Essieu / Eje	1	2	3	4	Gesamtgewicht / Total weight Poids total / Peso total
	(t)	12	12	12	12	48*
	(t)	10	10	10	10	40**

* Inkl. 11,0 t Gegengewicht, 9 m / 16 m Auslegerverlängerung, 32 t Unterflasche, 6 t Hakengeschirr, Werkzeugkasten, Antrieb 8 x 6, Bereifung 445/95 R 25 (16.00 R 25).

* Incl. 11.0 t counterweight, 9 m / 16 m boom extension, 32 t hook block, 6 t swivel hook, toolbox, drive 8 x 6, tyres 445/95 R 25 (16.00 R 25).

* Incl. de 11,0 t contrepoids, 9 m / 16 m fléchette, 32 t moufle, 6 t elingues, boîte à outils, entraînement 8 x 6, pneus 445/95 R 25 (16.00 R 25).

* Incl. contrapeso de 11,0 t, 9 m / 16 m plumín, 32 t gancho, 6 t gancho de bola, caja de herramientas, tracción 8 x 6, neumáticos 445/95 R 25 (16.00 R 25).

** Inkl. 3,4 t Gegengewicht, 9 m / 16 m Auslegerverlängerung, 32 t Unterflasche, Werkzeugkasten, Antrieb 8 x 6, Bereifung 445/95 R 25 (16.00 R 25).

** Incl. 3.4 t counterweight, 9 m / 16 m boom extension, 32 t hook block, toolbox, drive 8 x 6, tyres 445/95 R 25 (16.00 R 25).

** Incl. de 3,4 t contrepoids, 9 m / 16 m fléchette, 32 t moufle, boîte à outils, entraînement 8 x 6, pneus 445/95 R 25 (16.00 R 25).

** Incl. contrapeso de 3,4 t, 9 m / 16 m plumín, 32 t gancho, caja de herramientas, tracción 8 x 6, neumáticos 445/95 R 25 (16.00 R 25).

	Traglast / Lifting capacity / Force de levage / Capacidad de elevación	Rollen / Sheaves Pulies / Poleas	Stränge / Parts of line Brins / Ramales de cable	Gewicht / Weight Poid / Peso
	47.4 t (Typ / Type / Typo 50)*	5	11	475 kg
	30.5 t (Typ / Type / Typo 32)*	3	7	300 kg
	30.5 t (Typ / Type / Typo 32)	3	7	300 kg
	13.2 t (Typ / Type / Typo 16)	1	2	185 kg
4.5 t (Typ / Type / Typo 6)	–	1	150 kg	

* Doppelhaken

* Rams horn

* Moufle avec crochet marin

* Gancho doble



	Tire	1	2	3	4	5	6	7	8	9	10	11	12	R1	R2	
	385/95 R 25 (14.00 R 25)	3	4	5	6	8	10	13	17	22	28	36	46	3	4	74%
	km/h	5	7	9	12	15	19	25	32	41	52	67	85	6	8	34%
	445/95 R 25 (16.00 R 25)	3	4	5	7	9	11	15	19	24	31	39	50	3	4	65%
	km/h	6	8	10	13	16	20	27	34	44	57	72	85	6	8	30%

V+	Stufenlos Infinitely variable Progressivement variable Infinitamente variable	Seil Rope Câble Cable	Max. Seilzug Max. single line pull Effort maxi au brin simple Trio máximo por ramal
	0 - 130 m/min für einfachen Strang single line au brin simple ramal simple	16 mm / 205 m	44 kN
	0 - 130 m/min für einfachen Strang single line au brin simple ramal simple	16 mm / 205 m	44 kN
	0 - 2 min ⁻¹		0° + 180°
	- 2° – + 82°	ca. 33 s approx. 33 s env. 33 s aproximadamente 33 s	
	11.1 m – 52.1 m	ca. 500 s approx. 500 s env. 500 s aproximadamente 500 s	

Hubhöhen
Lifting heights
Hauteurs de levage
Alturas de elevación

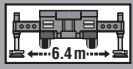
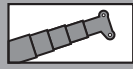

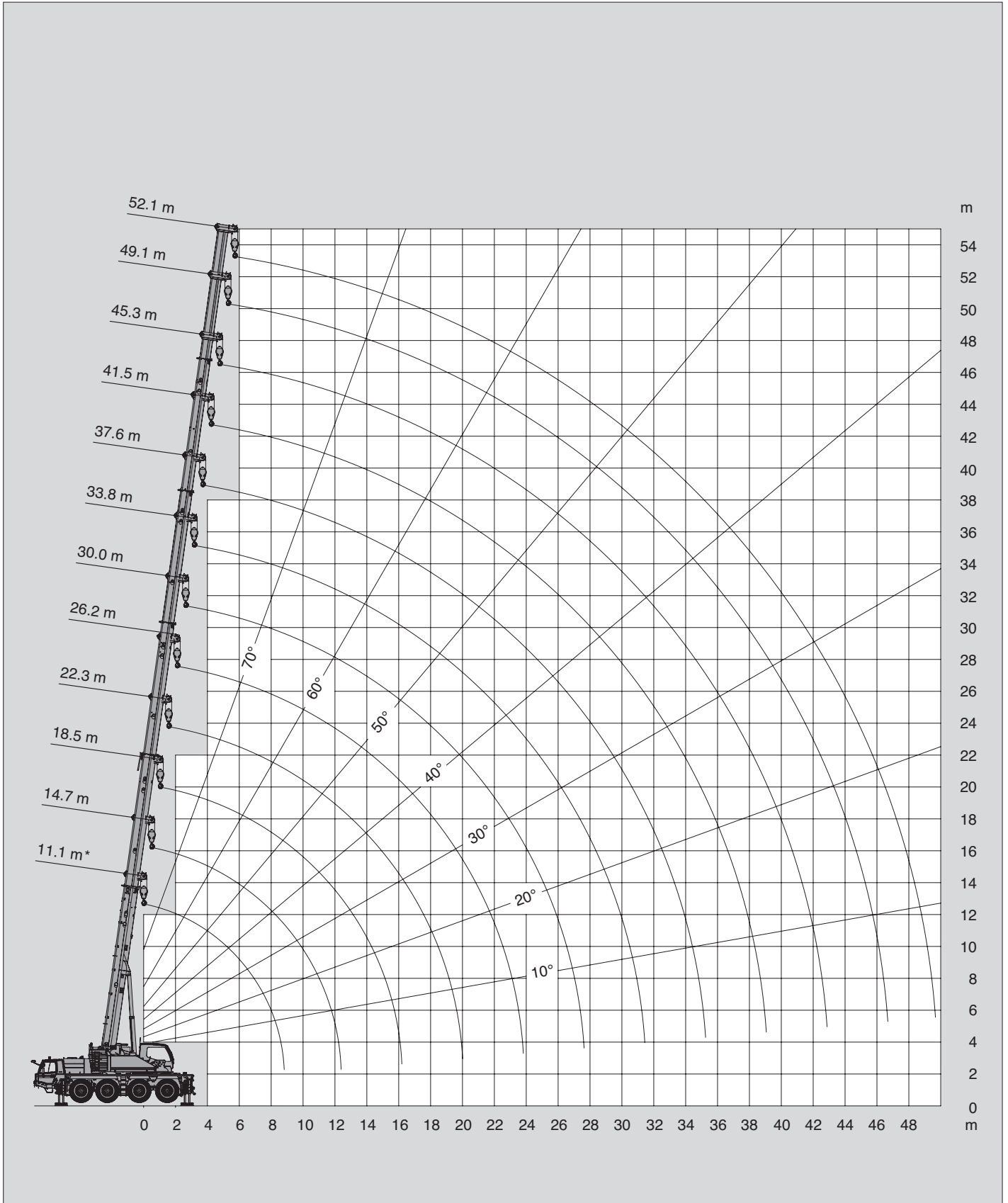

16.5t

DIN/ISO/EN



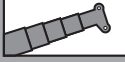
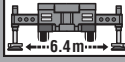

Tragfähigkeiten
Lifting capacities
Capacités de levage
Capacidades de elevación

   16.5t DIN/ISO/EN													
 m	11.1 m*	11.1 m	14.7 m	18.5 m	22.3 m	26.2 m	30.0 m	33.8 m	37.6 m	41.5 m	45.3 m	49.1 m	52.1 m
2.5	70.0**	57.7**											
3.0	59.3**	52.5**	50.4	49.0									
3.5	54.4**	48.2	46.2	44.8	39.9								
4.0	50.2	44.4	42.6	41.3	39.9	30.8							
4.5	44.2	41.1	39.6	38.3	37.4	28.7	23.9						
5.0	39.5	37.4	37.2	35.7	34.9	26.9	23.9	17.6					
6.0	32.3	31.3	31.5	31.2	30.6	26.2	22.8	18.6	14.2				
7.0	27.2	26.8	26.9	26.6	26.7	26.0	20.8	18.6	14.2	10.6			
8.0	23.4	23.1	23.3	23.0	23.1	23.5	20.4	17.6	14.2	10.6	8.3		
9.0			20.6	20.0	20.1	20.5	19.0	16.4	14.2	10.6	8.3	6.8	
10.0			18.2	17.6	18.4	18.1	17.8	15.1	13.3	10.6	8.3	6.8	5.8
12.0			14.4	14.8	14.7	14.7	14.8	12.9	11.7	10.6	8.3	6.8	5.8
14.0				11.4	11.7	11.8	11.5	11.1	10.4	9.5	8.3	6.8	5.8
16.0				9.0	9.6	9.5	9.1	8.9	9.1	8.5	7.9	6.8	5.8
18.0					7.9	7.7	7.6	7.8	7.4	7.4	7.1	6.6	5.8
20.0					6.4	6.4	6.8	6.5	6.2	6.1	6.3	6.0	5.7
22.0						5.9	5.7	5.4	5.6	5.5	5.2	5.3	5.3
24.0							4.9	4.9	4.8	4.7	4.7	4.4	4.5
26.0							4.2	4.4	4.1	4.0	4.0	3.7	3.8
28.0								3.8	3.8	3.6	3.4	3.2	3.2
30.0								3.3	3.3	3.1	2.9	2.7	2.7
32.0									2.8	2.7	2.5	2.2	2.3
34.0									2.5	2.3	2.2	1.9	1.9
36.0										2.0	1.8	1.6	1.6
38.0										1.7	1.5	1.3	1.3
40.0											1.3	1.0	1.0
42.0											1.1	0.8	0.8
44.0												0.6	0.6

* Nach hinten / * Over rear / * A l'arrière / * Sobre la parte trasera

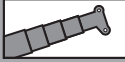
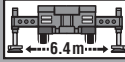

** Mit Zusatzhubausrüstung / ** With additional lifting equipment / ** Avec équipement supplémentaire / * Con equipo adicional

   12.2t DIN/ISO/EN													
 m	11.1 m*	11.1 m	14.7 m	18.5 m	22.3 m	26.2 m	30.0 m	33.8 m	37.6 m	41.5 m	45.3 m	49.1 m	52.1 m
2.5	70.0**	57.7**											
3.0	59.3**	52.5**	50.4	49.0									
3.5	54.4**	48.2	46.2	44.8	39.9								
4.0	47.7	44.1	42.6	41.3	39.9	30.8							
4.5	42.1	39.7	39.6	38.3	37.4	28.7	23.9						
5.0	37.6	36.0	36.2	35.7	34.9	26.9	23.9	17.6					
6.0	30.7	30.1	30.3	29.9	30.3	26.2	22.8	18.6	14.2				
7.0	25.8	25.6	25.7	25.4	25.8	26.0	20.8	18.6	14.2	10.6			
8.0	22.2	21.9	22.4	21.8	22.1	22.0	20.4	17.6	14.2	10.6	8.3		
9.0			19.5	18.9	19.7	18.7	18.5	16.4	14.2	10.6	8.3	6.8	
10.0			16.8	17.2	17.1	16.7	16.1	15.0	13.3	10.6	8.3	6.8	5.8
12.0			12.1	12.5	13.1	13.0	12.5	11.6	11.4	10.6	8.3	6.8	5.8
14.0				9.9	10.1	9.9	9.6	9.8	9.4	9.1	8.3	6.8	5.8
16.0				7.9	8.0	7.8	8.2	7.9	7.5	7.5	7.5	6.8	5.8
18.0					6.5	6.9	6.7	6.4	6.6	6.5	6.3	6.1	5.8
20.0					5.3	5.7	5.5	5.7	5.4	5.4	5.4	5.1	5.1
22.0						4.8	4.6	4.8	4.8	4.6	4.5	4.2	4.2
24.0							3.9	4.1	4.1	3.9	3.7	3.5	3.5
26.0							3.3	3.5	3.4	3.3	3.1	2.8	2.9
28.0								2.9	2.9	2.8	2.6	2.3	2.3
30.0								2.5	2.5	2.3	2.2	1.9	1.9
32.0									2.1	1.9	1.8	1.5	1.5
34.0									1.8	1.6	1.5	1.2	1.2
36.0										1.3	1.2	0.9	0.9
38.0										1.1	1.0	0.7	0.7
40.0											0.7	0.5	
42.0											0.5		

* Nach hinten / * Over rear / * A l'arrière / * Sobre la parte trasera

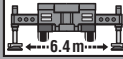

** Mit Zusatzhubausrüstung / ** With additional lifting equipment / ** Avec équipement supplémentaire / * Con equipo adicional

Tragfähigkeiten
Lifting capacities
Capacités de levage
Capacidades de elevación

   11.0t DIN/ISO/EN													
→ m	11.1 m*	11.1 m	14.7 m	18.5 m	22.3 m	26.2 m	30.0 m	33.8 m	37.6 m	41.5 m	45.3 m	49.1 m	52.1 m
2.5	70.0**	57.7**											
3.0	59.3**	52.5**	50.4	49.0									
3.5	54.2**	48.2	46.2	44.8	39.9								
4.0	47.1	43.7	42.6	41.3	39.9	30.8							
4.5	41.5	39.3	39.5	38.3	37.4	28.7	23.9						
5.0	37.0	35.6	35.8	35.5	34.9	26.9	23.9	17.6					
6.0	30.3	29.7	29.9	29.6	29.9	26.2	22.8	18.6	14.2				
7.0	25.5	25.2	25.4	25.1	25.4	25.1	20.8	18.6	14.2	10.6			
8.0	21.8	21.6	22.0	21.4	22.1	21.0	20.4	17.6	14.2	10.6	8.3		
9.0			19.2	18.7	19.1	17.9	17.7	16.4	14.2	10.6	8.3	6.8	
10.0			16.0	16.4	16.3	16.4	15.3	14.2	13.3	10.6	8.3	6.8	5.8
12.0			11.8	12.3	12.5	12.3	11.9	11.0	11.1	10.6	8.3	6.8	5.8
14.0				9.4	9.5	9.4	9.1	9.5	8.9	8.6	8.3	6.8	5.8
16.0				7.4	7.5	7.5	7.8	7.5	7.3	7.5	7.0	6.8	5.8
18.0					6.1	6.5	6.3	6.2	6.2	6.1	6.2	5.8	5.7
20.0					5.0	5.4	5.2	5.4	5.2	5.2	5.1	4.8	4.7
22.0						4.5	4.3	4.5	4.5	4.3	4.2	3.9	3.9
24.0							2.6	3.6	3.8	3.6	3.5	3.2	3.2
26.0								3.1	3.2	3.2	2.9	2.6	2.6
28.0									2.7	2.7	2.5	2.1	2.1
30.0									2.3	2.3	2.1	1.7	1.7
32.0										1.9	1.7	1.3	1.3
34.0										1.6	1.3	1.0	1.0
36.0											1.2	0.8	0.8
38.0											0.9	0.8	0.5
40.0											0.6		

* Nach hinten / * Over rear / * A l'arrière / * Sobre la parte trasera

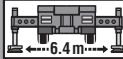

** Mit Zusatzhubausrüstung / ** With additional lifting equipment / ** Avec équipement supplémentaire / ** Con equipo adicional

   10.2t DIN/ISO/EN													
→ m	11.1 m*	11.1 m	14.7 m	18.5 m	22.3 m	26.2 m	30.0 m	33.8 m	37.6 m	41.5 m	45.3 m	49.1 m	52.1 m
2.5	70.0**	57.7**											
3.0	59.3**	52.5**	50.4	49.0									
3.5	53.7**	48.2	46.2	44.8	39.9								
4.0	46.6	43.4	42.6	41.3	39.9	30.8							
4.5	41.1	39.1	38.9	38.3	37.4	28.7	23.9						
5.0	36.7	35.4	35.2	35.2	34.9	26.9	23.9	17.6					
6.0	30.0	29.5	29.6	29.3	29.7	26.2	22.8	17.6	14.2				
7.0	25.2	25.0	25.1	24.8	25.1	24.4	20.8	17.6	14.2	10.6			
8.0	21.6	21.4	21.8	21.2	21.8	20.3	20.0	17.6	14.2	10.6	8.3		
9.0			18.8	18.7	18.4	17.9	17.1	15.8	14.2	10.6	8.3	6.8	
10.0			15.4	15.8	15.7	15.8	14.8	13.7	13.2	10.6	8.3	6.8	5.8
12.0			11.3	11.9	12.0	11.9	11.4	10.9	10.7	10.3	8.3	6.8	5.8
14.0				9.1	9.2	9.0	9.1	9.1	8.5	8.4	8.0	6.8	5.8
16.0				7.1	7.2	7.5	7.5	7.2	7.3	7.3	7.0	6.6	5.8
18.0					5.8	6.2	6.1	6.2	5.9	5.9	5.9	5.5	5.4
20.0					4.8	5.2	5.0	5.2	5.2	5.0	4.8	4.5	4.5
22.0						4.3	4.1	4.3	4.3	4.1	4.0	3.7	3.7
24.0						2.4	3.4	3.6	3.6	3.4	3.3	3.0	3.0
26.0							2.9	3.0	3.0	2.8	2.7	2.4	2.4
28.0								2.6	2.6	2.4	2.2	2.0	2.0
30.0								2.2	2.1	2.0	1.8	1.5	1.6
32.0									1.8	1.6	1.5	1.2	1.2
34.0									1.5	1.3	1.2	0.9	0.9
36.0										1.0	0.9	0.6	0.6
38.0										0.8	0.7		
40.0											0.5		

* Nach hinten / * Over rear / * A l'arrière / * Sobre la parte trasera

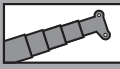
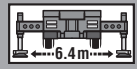

** Mit Zusatzhubausrüstung / ** With additional lifting equipment / ** Avec équipement supplémentaire / ** Con equipo adicional

Tragfähigkeiten
Lifting capacities
Capacités de levage
Capacidades de elevación

   4.4 t DIN/ISO/EN													
→ m	11.1 m*	11.1 m	14.7 m	18.5 m	22.3 m	26.2 m	30.0 m	33.8 m	37.6 m	41.5 m	45.3 m	49.1 m	52.1 m
2.5	70.0**	57.7**											
3.0	58.8**	52.5**	50.4	49.0									
3.5	50.0	46.4	46.2	44.8	39.9								
4.0	43.4	41.2	41.4	41.0	39.9	30.8							
4.5	38.2	36.9	37.1	36.7	36.8	28.7	23.9						
5.0	34.0	33.3	33.5	33.1	32.3	26.9	23.9	17.6					
6.0	27.8	27.6	27.7	26.0	25.6	23.3	21.2	18.6	14.2				
7.0	23.2	22.6	23.0	21.8	20.3	19.9	18.3	16.8	14.2	10.6			
8.0	18.0	17.0	17.8	17.7	17.6	16.5	15.2	14.0	13.3	10.6	8.3		
9.0			14.0	15.0	14.8	13.9	12.9	12.8	11.8	10.6	8.3	6.8	
10.0			11.7	12.3	12.5	12.0	11.5	11.1	10.2	9.7	8.3	6.8	5.8
12.0			8.2	8.8	8.9	9.4	9.2	8.6	8.4	8.3	7.4	6.8	5.8
14.0				6.5	6.6	7.1	6.9	7.1	7.1	6.6	6.2	5.7	5.6
16.0				5.0	5.1	5.5	5.3	5.5	5.5	5.3	5.0	4.5	4.4
18.0					4.0	4.4	4.2	4.4	4.4	4.2	4.1	3.6	3.6
20.0					3.1	3.5	3.3	3.5	3.5	3.3	3.2	2.9	2.9
22.0						2.8	2.7	2.8	2.8	2.6	2.5	2.2	2.2
24.0						1.1	2.1	2.3	2.3	2.1	1.9	1.7	1.7
26.0							1.7	1.8	1.8	1.6	1.5	1.2	1.2
28.0								1.4	1.4	1.3	1.1		
30.0								1.1	1.1	0.9	0.8		
32.0									0.8	0.7			
34.0									0.6				

* Nach hinten / * Over rear / * A l'arrière / * Sobre la parte trasera

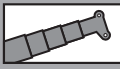
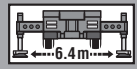
** Mit Zusatzhubausrüstung / ** With additional lifting equipment / ** Avec équipement supplémentaire / * Con equipo adicional

   3.4 t DIN/ISO/EN													
→ m	11.1 m*	11.1 m	14.7 m	18.5 m	22.3 m	26.2 m	30.0 m	33.8 m	37.6 m	41.5 m	45.3 m	49.1 m	52.1 m
2.5	70.0**	57.7**											
3.0	58.0**	52.2**	50.4	49.0									
3.5	49.3	45.9	45.7	44.8	39.9								
4.0	42.8	40.8	41.0	40.6	39.9	30.8							
4.5	37.7	36.5	36.7	36.3	35.4	28.7	23.9						
5.0	33.6	32.9	33.1	32.7	31.0	26.9	23.9	17.6					
6.0	27.4	27.2	27.3	24.6	24.2	22.1	20.8	18.6	14.2				
7.0	22.1	21.4	21.8	20.6	19.4	18.9	17.3	15.9	14.2	10.6			
8.0	17.2	16.0	16.8	16.8	16.7	15.6	14.4	13.2	12.9	10.6	8.3		
9.0			13.5	14.2	14.0	13.2	12.2	12.1	11.1	10.5	8.3	6.8	
10.0			11.0	11.6	11.7	11.3	11.3	10.4	10.2	9.1	8.3	6.8	5.8
12.0			7.6	8.2	8.3	8.8	8.6	8.6	8.1	7.8	7.3	6.7	5.8
14.0				6.1	6.2	6.6	6.5	6.7	6.6	6.2	5.8	5.3	5.2
16.0				4.6	4.7	5.1	5.0	5.2	5.2	5.0	4.7	4.2	4.1
18.0					3.6	4.0	3.9	4.1	4.1	3.9	3.7	3.3	3.3
20.0					2.8	3.2	3.0	3.2	3.2	3.0	2.9	2.6	2.6
22.0						2.6	2.4	2.6	2.6	2.4	2.2	2.0	2.0
24.0						0.8	1.9	2.0	2.0	1.9	1.7	1.4	1.4
26.0							1.5	1.6	1.6	1.4	1.3		
28.0								1.2	1.2	1.1	0.9		
30.0								0.9	0.9	0.7			
32.0									0.7	0.5			
34.0									0.5				

* Nach hinten / * Over rear / * A l'arrière / * Sobre la parte trasera

** Mit Zusatzhubausrüstung / ** With additional lifting equipment / ** Avec équipement supplémentaire / * Con equipo adicional

Hubhöhen
Lifting heights
Hauteurs de levage
Alturas de elevación





16.5t
DIN/ISO/EN

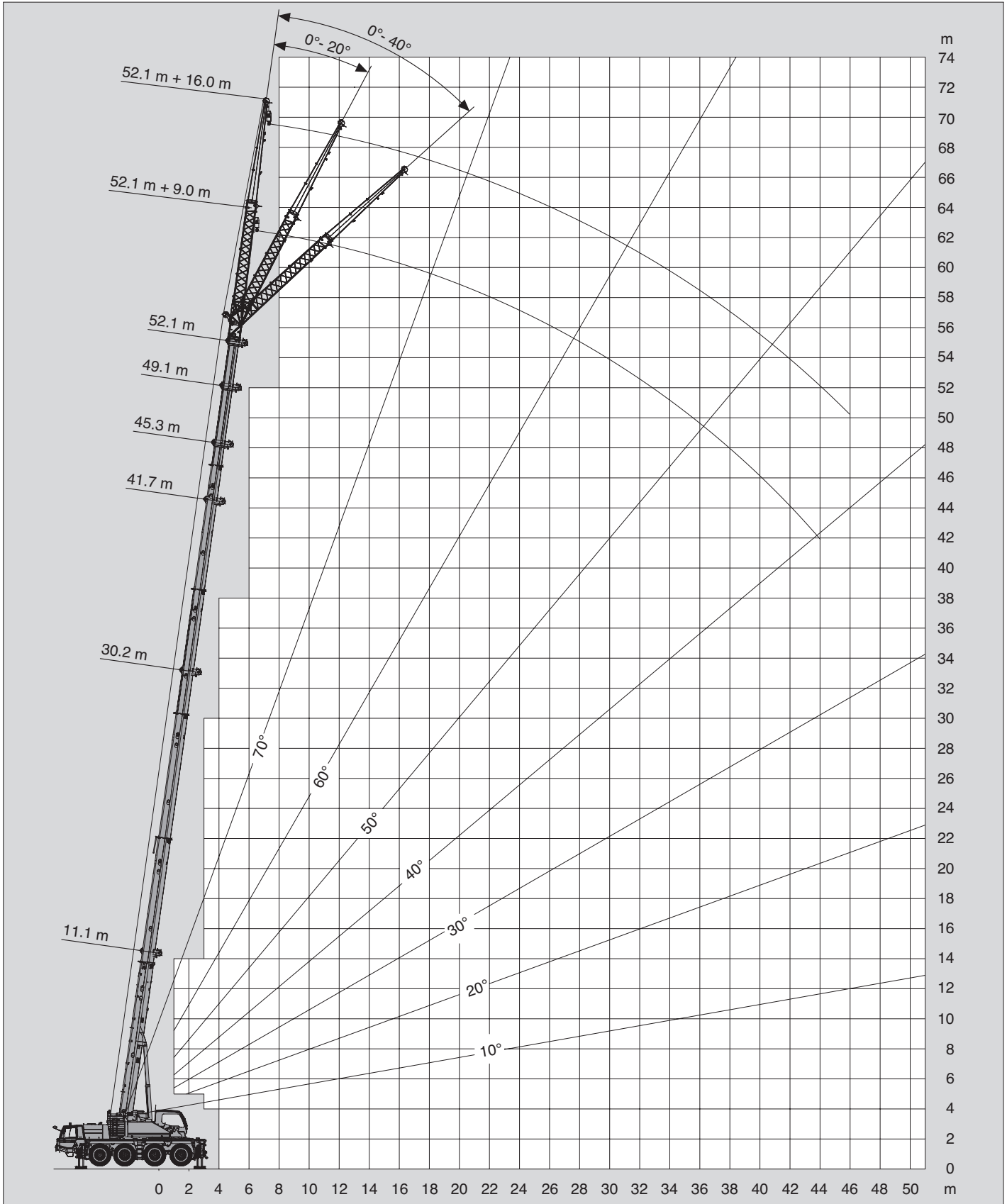

Tragfähigkeiten
Lifting capacities
Capacités de levage
Capacidades de elevación



m	11.1 m + 9.0 m			30.2 m + 9.0 m			41.7 m + 9.0 m			45.3 m + 9.0 m			49.1 m + 9.0 m			52.1 m + 9.0 m		
	0°	20°	40°	0°	20°	40°	0°	20°	40°	0°	20°	40°	0°	20°	40°	0°	20°	40°
2.5	10.5*																	
3.0	10.5*																	
3.5	10.5*																	
4.0	10.5*	10.5*																
4.5	10.5*	10.5*		10.3*														
5.0	10.5*	10.5*		10.3*														
6.0	10.5*	10.5*		10.3*														
7.0	10.5*	10.3*	8.6	10.3*														
8.0	10.5*	9.7*	8.2	10.3*	8.8			5.7			4.2							
9.0	10.5*	9.2*	7.8	10.3*	8.8			5.7			4.2			3.5				
10.0	10.5*	8.7	7.5	10.3*	8.8			5.7			4.2			3.5			2.4	
12.0	9.3*	7.9	7.1	10.1*	8.8	7.8	5.7	5.7			4.2	4.2		3.5	3.5		2.4	
14.0	8.3	7.3	6.7	9.0*	8.6	7.5	5.7	5.3	5.0	4.2	4.2	3.8	3.5	3.5			2.4	2.4
16.0	7.5	6.8		8.1	7.8	7.3	5.3	4.9	4.6	4.2	4.0	3.5	3.5	3.4	3.1		2.4	2.4
18.0				7.1	7.1	7.0	4.9	4.5	4.3	4.2	3.7	3.4	3.5	3.2	2.9		2.4	2.4
20.0				5.8	6.2	6.4	4.5	4.2	4.0	4.0	3.5	3.2	3.4	3.0	2.8		2.4	2.4
22.0				4.7	5.1	5.4	4.2	3.9	3.8	3.8	3.3	3.1	3.2	2.8	2.6		2.4	2.4
24.0				3.9	4.2	4.4	3.8	3.7	3.5	3.5	3.2	2.9	3.0	2.7	2.5		2.4	2.4
26.0				3.2	3.5	3.7	3.3	3.5	3.3	3.3	3.0	2.8	2.8	2.5	2.4		2.4	2.4
28.0				2.6	2.9	3.0	2.7	3.0	3.2	2.9	2.9	2.7	2.7	2.4	2.3		2.4	2.3
30.0				2.2	2.3	2.4	2.2	2.5	2.6	2.4	2.7	2.6	2.5	2.3	2.2		2.4	2.2
32.0				1.7	1.9		1.8	2.0	2.2	2.0	2.2	2.4	2.2	2.2	2.1		2.1	2.1
34.0				1.4	1.5		1.4	1.6	1.7	1.6	1.8	2.0	1.8	2.0	2.0		1.8	2.0
36.0				1.1			1.1	1.3	1.4	1.3	1.5	1.6	1.5	1.6	1.8		1.4	1.6
38.0							0.8	1.0	1.0	1.0	1.2	1.3	1.2	1.3	1.4		1.1	1.3
40.0								0.7	0.7	0.8	0.9	1.0	0.9	1.1	1.1		0.9	1.0
42.0											0.7	0.7					0.8	0.9
44.0															0.6			

* Mit Zusatzhubausrüstung / * With additional lifting equipment / * Avec équipement supplémentaire / * Con equipo adicional

m	11.1 m + 16.0 m			30.2 m + 16.0 m			41.7 m + 16.0 m			45.3 m + 16.0 m			49.1 m + 16.0 m			52.1 m + 16.0 m		
	0°	20°	40°	0°	20°	40°	0°	20°	40°	0°	20°	40°	0°	20°	40°	0°	20°	40°
2.5	7.9																	
3.0	7.9																	
3.5	7.9																	
4.0	7.9																	
4.5	7.9																	
5.0	7.9																	
6.0	7.9			5.2														
7.0	7.4			5.2														
8.0	7.0	5.6		5.2														
9.0	6.5	5.3		5.2			3.2			2.8								
10.0	6.1	5.0		5.2			3.2			2.8			2.4					
12.0	5.5	4.6	4.0	5.2	4.8		3.2			2.8			2.4				1.7	
14.0	4.9	4.2	3.8	5.2	4.5		3.2			2.8			2.4				1.7	
16.0	4.5	3.9	3.5	5.2	4.3	3.7	3.2	3.2		2.8	2.8		2.4				1.7	
18.0	4.1	3.6	3.4	5.2	4.1	3.5	3.2	3.2		2.8	2.8		2.4	2.4			1.7	1.7
20.0	3.8	3.4	3.2	4.9	3.9	3.4	3.2	3.2	3.2	2.8	2.7	2.3	2.4	2.3			1.7	1.7
22.0	3.5	3.3	3.2	4.6	3.7	3.3	3.2	3.2	3.2	2.8	2.5	2.2	2.4	2.2	1.9		1.7	1.7
24.0	3.3	3.2		4.3	3.6	3.2	3.2	3.2	3.0	2.8	2.4	2.1	2.4	2.1	1.8		1.7	1.7
26.0				3.6	3.5	3.1	3.2	3.0	2.8	2.7	2.3	2.0	2.3	1.9	1.8		1.7	1.7
28.0				3.0	3.3	3.0	3.0	2.8	2.7	2.5	2.2	1.9	2.1	1.8	1.7		1.7	1.6
30.0				2.5	3.0	3.0	2.5	2.6	2.5	2.4	2.1	1.9	2.0	1.8	1.6		1.7	1.5
32.0				2.1	2.5	2.8	2.1	2.5	2.4	2.2	2.0	1.8	1.9	1.7	1.5		1.7	1.5
34.0				1.7	2.1	2.3	1.7	2.1	2.3	1.8	1.9	1.7	1.8	1.6	1.5		1.7	1.5
36.0				1.4	1.7	1.9	1.4	1.7	2.0	1.5	1.8	1.7	1.6	1.5	1.4		1.5	1.3
38.0				1.1	1.4	1.5	1.1	1.4	1.6	1.2	1.5	1.6	1.3	1.5	1.4		1.2	1.3
40.0				0.9	1.1		0.8	1.1	1.3	0.9	1.2	1.4	1.0	1.3	1.3		1.0	1.2
42.0				0.7	0.8		0.6	0.8	1.0	0.7	1.0	1.1	0.8	1.1	1.2		0.7	1.0
44.0									0.7			0.9		0.8	1.0			1.0
46.0														0.7				0.7

Tragfähigkeiten
Lifting capacities
Capacités de levage
Capacidades de elevación



DIN/ISO/EN

m	11.1 m + 9.0 m			30.2 m + 9.0 m			41.7 m + 9.0 m			45.3 m + 9.0 m			49.1 m + 9.0 m			52.1 m + 9.0 m			
	0°	20°	40°	0°	20°	40°	0°	20°	40°	0°	20°	40°	0°	20°	40°	0°	20°	40°	
2.5	10.5*																		
3.0	10.5*																		
3.5	10.5*																		
4.0	10.5*	10.5*																	
4.5	10.5*	10.5*		10.3*															
5.0	10.5*	10.5*		10.3*															
6.0	10.5*	10.5*		10.3*															
7.0	10.5*	10.3*	8.6	10.3*															
8.0	10.5*	9.7*	8.2	10.3*	8.8		5.7			4.2									
9.0	10.5*	9.2*	7.8	10.3*	8.8		5.7			4.2			3.5						
10.0	10.5*	8.7	7.5	10.3*	8.8		5.7			4.2			3.5			2.4			
12.0	9.3*	7.9	7.1	10.1*	8.8	7.8	5.7	5.7		4.2	4.2		3.5	3.5		2.4			
14.0	8.3	7.3	6.7	8.9*	8.6	7.5	5.7	5.3	5.0	4.2	4.2	3.8	3.5	3.5		2.4	2.4		
16.0	7.5	6.8		7.2	7.8	7.3	5.3	4.9	4.6	4.2	4.0	3.5	3.5	3.4	3.1	2.4	2.4	2.4	
18.0				5.7	6.2	6.7	4.9	4.5	4.3	4.2	3.7	3.4	3.5	3.2	2.9	2.4	2.4	2.4	2.4
20.0				4.5	5.0	5.3	4.5	4.2	4.0	4.0	3.5	3.2	3.4	3.0	2.8	2.4	2.4	2.4	2.4
22.0				3.6	4.0	4.3	3.7	3.9	3.8	3.8	3.3	3.1	3.2	2.8	2.6	2.4	2.4	2.4	2.4
24.0				2.9	3.2	3.5	3.0	3.4	3.5	3.2	3.2	2.9	3.0	2.7	2.5	2.4	2.4	2.4	2.4
26.0				2.3	2.6	2.8	2.4	2.7	3.0	2.6	3.0	2.8	2.8	2.5	2.4	2.4	2.4	2.4	2.3
28.0				1.8	2.0	2.2	1.9	2.2	2.4	2.1	2.4	2.6	2.3	2.4	2.3	2.2	2.3	2.2	2.2
30.0				1.4	1.6	1.7	1.5	1.7	1.9	1.7	1.9	2.1	1.8	2.1	2.2	1.8	2.1	2.1	2.1
32.0				1.0	1.2		1.1	1.3	1.5	1.3	1.5	1.7	1.4	1.7	1.8	1.4	1.7	1.8	1.8
34.0				0.7	0.8		0.8	1.0	1.1	1.0	1.2	1.3	1.1	1.3	1.5	1.1	1.3	1.5	1.5
36.0				0.5			0.5	0.7	0.7	0.7	0.9	1.0	0.8	1.0	1.1	0.8	1.0	1.1	1.1
38.0									0.5		0.6	0.7	0.6	0.7	0.8	0.7	0.8	0.8	0.8
40.0													0.6	0.7	0.6				

* Mit Zusatzhubausrüstung / * With additional lifting equipment / * Avec équipement supplémentaire / * Con equipo adicional

m	11.1 m + 16.0 m			30.2 m + 16.0 m			41.7 m + 16.0 m			45.3 m + 16.0 m			49.1 m + 16.0 m			52.1 m + 16.0 m			
	0°	20°	40°	0°	20°	40°	0°	20°	40°	0°	20°	40°	0°	20°	40°	0°	20°	40°	
2.5	7.9																		
3.0	7.9																		
3.5	7.9																		
4.0	7.9																		
4.5	7.9																		
5.0	7.9																		
6.0	7.9			5.2															
7.0	7.4			5.2															
8.0	7.0	5.6		5.2															
9.0	6.5	5.3		5.2			3.2			2.8									
10.0	6.1	5.0		5.2			3.2			2.8			2.4						
12.0	5.5	4.6	4.0	5.2	4.8		3.2			2.8			2.4			1.7			
14.0	4.9	4.2	3.8	5.2	4.5		3.2			2.8			2.4			1.7			
16.0	4.5	3.9	3.5	5.2	4.3	3.7	3.2	3.2		2.8	2.8		2.4			1.7			
18.0	4.1	3.6	3.4	5.2	4.1	3.5	3.2	3.2		2.8	2.8		2.4	2.4		1.7	1.7		
20.0	3.8	3.4	3.2	4.9	3.9	3.4	3.2	3.2	3.2	2.8	2.7	2.3	2.4	2.3		1.7	1.7		
22.0	3.5	3.3	3.2	4.1	3.7	3.3	3.2	3.2	3.2	2.8	2.5	2.2	2.4	2.2	1.9	1.7	1.7	1.7	1.7
24.0	3.3	3.2		3.3	3.6	3.2	3.2	3.2	3.0	2.8	2.4	2.1	2.4	2.1	1.8	1.7	1.7	1.7	1.7
26.0				2.7	3.3	3.1	2.7	3.0	2.8	2.7	2.3	2.0	2.3	1.9	1.8	1.7	1.7	1.7	1.7
28.0				2.2	2.7	3.0	2.2	2.7	2.7	2.3	2.2	1.9	2.1	1.8	1.7	1.7	1.7	1.7	1.6
30.0				1.8	2.2	2.6	1.7	2.2	2.5	1.8	2.1	1.9	1.9	1.8	1.6	1.7	1.7	1.7	1.5
32.0				1.4	1.8	2.1	1.4	1.8	2.2	1.5	1.9	1.8	1.6	1.7	1.5	1.5	1.6	1.5	1.5
34.0				1.1	1.4	1.7	1.0	1.4	1.7	1.1	1.5	1.7	1.2	1.6	1.5	1.2	1.5	1.4	1.4
36.0				0.8	1.1	1.3	0.7	1.1	1.4	0.8	1.2	1.5	0.9	1.3	1.4	0.9	1.3	1.3	1.3
38.0				0.6	0.8	0.9		0.8	1.0	0.6	0.9	1.2	0.7	1.0	1.3		1.0	1.3	1.3
40.0					0.5			0.6	0.7		0.7	0.9		0.8	1.0		0.7	1.0	1.0
42.0												0.6			0.7				0.7

Tragfähigkeiten
Lifting capacities
Capacités de levage
Capacidades de elevación



m	11.1 m + 9.0 m			30.2 m + 9.0 m			41.7 m + 9.0 m			45.3 m + 9.0 m			49.1 m + 9.0 m			52.1 m + 9.0 m		
	0°	20°	40°	0°	20°	40°	0°	20°	40°	0°	20°	40°	0°	20°	40°	0°	20°	40°
2.5	10.5*																	
3.0	10.5*																	
3.5	10.5*																	
4.0	10.5*	10.5*																
4.5	10.5*	10.5*		10.3*														
5.0	10.5*	10.5*		10.3*														
6.0	10.5*	10.5*		10.3*														
7.0	10.5*	10.3*	8.6	10.3*														
8.0	10.5*	9.7*	8.2	10.3*	8.8		5.7			4.2								
9.0	10.5*	9.2*	7.8	10.3*	8.8		5.7			4.2			3.5					
10.0	10.5*	8.7	7.5	10.3*	8.8		5.7			4.2			3.5			2.4		
12.0	9.3*	7.9	7.1	10.1*	8.8	7.8	5.7	5.7		4.2	4.2		3.5	3.5		2.4		
14.0	8.3	7.3	6.7	8.4	8.6	7.5	5.7	5.3	5.0	4.2	4.2	3.8	3.5	3.5		2.4	2.4	
16.0	7.5	6.8		6.8	7.4	7.3	5.3	4.9	4.6	4.2	4.0	3.5	3.5	3.4	3.1	2.4	2.4	2.4
18.0				5.3	5.9	6.3	4.9	4.5	4.3	4.2	3.7	3.4	3.5	3.2	2.9	2.4	2.4	2.4
20.0				4.2	4.7	5.0	4.3	4.2	4.0	4.0	3.5	3.2	3.4	3.0	2.8	2.4	2.4	2.4
22.0				3.3	3.7	4.0	3.4	3.8	3.8	3.6	3.3	3.1	3.2	2.8	2.6	2.4	2.4	2.4
24.0				2.6	3.0	3.2	2.7	3.1	3.4	3.0	3.2	2.9	3.0	2.7	2.5	2.4	2.4	2.4
26.0				2.1	2.3	2.5	2.1	2.5	2.7	2.4	2.7	2.8	2.5	2.5	2.4	2.4	2.4	2.3
28.0				1.6	1.8	1.9	1.7	1.9	2.1	1.9	2.2	2.4	2.0	2.3	2.3	2.0	2.3	2.2
30.0				1.2	1.4	1.5	1.2	1.5	1.7	1.5	1.7	1.9	1.6	1.9	2.1	1.6	1.8	2.0
32.0				0.8	1.0		0.9	1.1	1.3	1.1	1.3	1.5	1.2	1.5	1.6	1.2	1.5	1.6
34.0				0.5	0.6		0.6	0.8	0.9	0.8	1.0	1.1	0.9	1.1	1.3	0.9	1.1	1.3
36.0									0.6		0.7	0.8	0.7	0.8	1.0	0.8	1.0	1.0
38.0													0.6	0.7	0.7			0.7

* Mit Zusatzhubausrüstung / * With additional lifting equipment / * Avec équipement supplémentaire / * Con equipo adicional

m	11.1 m + 16.0 m			30.2 m + 16.0 m			41.7 m + 16.0 m			45.3 m + 16.0 m			49.1 m + 16.0 m			52.1 m + 16.0 m		
	0°	20°	40°	0°	20°	40°	0°	20°	40°	0°	20°	40°	0°	20°	40°	0°	20°	40°
2.5	7.9																	
3.0	7.9																	
3.5	7.9																	
4.0	7.9																	
4.5	7.9																	
5.0	7.9																	
6.0	7.9			5.2														
7.0	7.4			5.2														
8.0	7.0	5.6		5.2														
9.0	6.5	5.3		5.2			3.2			2.8								
10.0	6.1	5.0		5.2			3.2			2.8			2.4					
12.0	5.5	4.6	4.0	5.2	4.8		3.2			2.8			2.4			1.7		
14.0	4.9	4.2	3.8	5.2	4.5		3.2			2.8			2.4			1.7		
16.0	4.5	3.9	3.5	5.2	4.3	3.7	3.2	3.2		2.8	2.8		2.4			1.7		
18.0	4.1	3.6	3.4	5.2	4.1	3.5	3.2	3.2		2.8	2.8		2.4	2.4		1.7	1.7	
20.0	3.8	3.4	3.2	4.7	3.9	3.4	3.2	3.2	3.2	2.8	2.7	2.3	2.4	2.3		1.7	1.7	
22.0	3.5	3.3	3.2	3.8	3.7	3.3	3.2	3.2	3.2	2.8	2.5	2.2	2.4	2.2	1.9	1.7	1.7	1.7
24.0	3.3	3.2		3.1	3.6	3.2	3.0	3.2	3.0	2.8	2.4	2.1	2.4	2.1	1.8	1.7	1.7	1.7
26.0				2.5	3.0	3.1	2.5	3.0	2.8	2.6	2.3	2.0	2.3	1.9	1.8	1.7	1.7	1.7
28.0				2.0	2.5	2.9	2.0	2.5	2.7	2.1	2.2	1.9	2.1	1.8	1.7	1.7	1.7	1.6
30.0				1.6	2.0	2.4	1.5	2.0	2.4	1.6	2.1	1.9	1.7	1.8	1.6	1.7	1.7	1.5
32.0				1.2	1.6	1.9	1.2	1.6	2.0	1.3	1.7	1.8	1.4	1.7	1.5	1.3	1.6	1.5
34.0				0.9	1.2	1.5	0.9	1.3	1.6	1.0	1.4	1.7	1.0	1.4	1.5	1.0	1.4	1.4
36.0				0.6	0.9	1.1		0.9	1.2	0.7	1.0	1.3	0.8	1.1	1.4		1.1	1.3
38.0					0.6	0.7		0.7	0.9		0.8	1.0		0.9	1.1		0.8	1.1
40.0								0.6			0.7		0.8		0.8			0.8

Tragfähigkeiten
Lifting capacities
Capacités de levage
Capacidades de elevación



m	11.1 m + 9.0 m			30.2 m + 9.0 m			41.7 m + 9.0 m			45.3 m + 9.0 m			49.1 m + 9.0 m			52.1 m + 9.0 m			
	0°	20°	40°	0°	20°	40°	0°	20°	40°	0°	20°	40°	0°	20°	40°	0°	20°	40°	
2.5	10.5*																		
3.0	10.5*																		
3.5	10.5*																		
4.0	10.5*	10.5*																	
4.5	10.5*	10.5*		10.3*															
5.0	10.5*	10.5*		10.3*															
6.0	10.5*	10.5*		10.3*															
7.0	10.5*	10.3*	8.6	10.3*															
8.0	10.5*	9.7*	8.2	10.3*	8.8		5.7			4.2									
9.0	10.5*	9.2*	7.8	10.3*	8.8		5.7			4.2			3.5						
10.0	10.5*	8.7	7.5	10.3*	8.8		5.7			4.2			3.5			2.4			
12.0	9.3*	7.9	7.1	10.1*	8.8	7.8	5.7	5.7		4.2	4.2		3.5	3.5		2.4			
14.0	8.3	7.3	6.7	8.1	8.6	7.5	5.7	5.3	5.0	4.2	4.2	3.8	3.5	3.5		2.4	2.4		
16.0	7.5	6.8		6.5	7.1	7.3	5.3	4.9	4.6	4.2	4.0	3.5	3.5	3.4	3.1	2.4	2.4	2.4	
18.0				5.1	5.6	6.0	4.9	4.5	4.3	4.2	3.7	3.4	3.5	3.2	2.9	2.4	2.4	2.4	2.4
20.0				4.0	4.4	4.8	4.0	4.2	4.0	4.0	3.5	3.2	3.4	3.0	2.8	2.4	2.4	2.4	2.4
22.0				3.1	3.5	3.8	3.2	3.6	3.8	3.4	3.3	3.1	3.2	2.8	2.6	2.4	2.4	2.4	2.4
24.0				2.5	2.8	3.0	2.5	2.9	3.2	2.8	3.1	2.9	2.9	2.7	2.5	2.4	2.4	2.4	2.4
26.0				1.9	2.2	2.3	2.0	2.3	2.5	2.2	2.5	2.8	2.4	2.5	2.4	2.3	2.4	2.3	2.3
28.0				1.4	1.7	1.8	1.5	1.8	2.0	1.7	2.0	2.2	1.9	2.2	2.3	1.8	2.1	2.2	2.2
30.0				1.0	1.2	1.3	1.1	1.4	1.5	1.3	1.6	1.8	1.5	1.7	1.9	1.4	1.7	1.9	1.9
32.0				0.7	0.8			0.8	1.0	1.1	1.0	1.2	1.4	1.1	1.3	1.5	1.1	1.3	1.5
34.0					0.5				0.6	0.8	0.7	0.9	1.0	0.8	1.0	1.2	0.8	1.0	1.1
36.0											0.6	0.7		0.7	0.8		0.7	0.8	0.8

* Mit Zusatzhubausrüstung / * With additional lifting equipment / * Avec équipement supplémentaire / * Con equipo adicional

m	11.1 m + 16.0 m			30.2 m + 16.0 m			41.7 m + 16.0 m			45.3 m + 16.0 m			49.1 m + 16.0 m			52.1 m + 16.0 m			
	0°	20°	40°	0°	20°	40°	0°	20°	40°	0°	20°	40°	0°	20°	40°	0°	20°	40°	
2.5	7.9																		
3.0	7.9																		
3.5	7.9																		
4.0	7.9																		
4.5	7.9																		
5.0	7.9																		
6.0	7.9			5.2															
7.0	7.4			5.2															
8.0	7.0	5.6		5.2															
9.0	6.5	5.3		5.2			3.2			2.8									
10.0	6.1	5.0		5.2			3.2			2.8			2.4						
12.0	5.5	4.6	4.0	5.2	4.8		3.2			2.8			2.4			1.7			
14.0	4.9	4.2	3.8	5.2	4.5		3.2			2.8			2.4			1.7			
16.0	4.5	3.9	3.5	5.2	4.3	3.7	3.2	3.2		2.8	2.8		2.4			1.7			
18.0	4.1	3.6	3.4	5.2	4.1	3.5	3.2	3.2		2.8	2.8		2.4	2.4		1.7	1.7		
20.0	3.8	3.4	3.2	4.4	3.9	3.4	3.2	3.2	3.2	2.8	2.7	2.3	2.4	2.3		1.7	1.7		
22.0	3.5	3.3	3.2	3.6	3.7	3.3	3.2	3.2	3.2	2.8	2.5	2.2	2.4	2.2	1.9	1.7	1.7	1.7	1.7
24.0	3.3	3.2		2.9	3.5	3.2	2.8	3.2	3.0	2.8	2.4	2.1	2.4	2.1	1.8	1.7	1.7	1.7	1.7
26.0				2.3	2.9	3.1	2.3	2.9	2.8	2.4	2.3	2.0	2.3	1.9	1.8	1.7	1.7	1.7	1.7
28.0				1.8	2.3	2.8	1.8	2.3	2.7	1.9	2.2	1.9	2.0	1.8	1.7	1.7	1.7	1.6	1.6
30.0				1.4	1.8	2.2	1.4	1.9	2.3	1.5	2.0	1.9	1.6	1.8	1.6	1.5	1.7	1.5	1.5
32.0				1.1	1.4	1.8	1.0	1.5	1.8	1.1	1.6	1.8	1.2	1.7	1.5	1.2	1.6	1.5	1.5
34.0				0.8	1.1	1.3	0.7	1.1	1.4	0.8	1.2	1.5	0.9	1.3	1.5	0.9	1.3	1.4	1.4
36.0				0.5	0.8	1.0		0.8	1.1		0.9	1.2	1.0	1.3	1.0	1.3	1.0	1.3	1.3
38.0					0.5	0.6			0.8			0.9		0.7	1.0		1.0		1.0
40.0														0.7	0.7				1.0

Tragfähigkeiten
Lifting capacities
Capacités de levage
Capacidades de elevación



m	11.1 m + 9.0 m			30.2 m + 9.0 m			41.7 m + 9.0 m			45.3 m + 9.0 m			49.1 m + 9.0 m			52.1 m + 9.0 m		
	0°	20°	40°	0°	20°	40°	0°	20°	40°	0°	20°	40°	0°	20°	40°	0°	20°	40°
2.5	10.5*																	
3.0	10.5*																	
3.5	10.5*																	
4.0	10.5*	10.5*																
4.5	10.5*	10.5*		10.3*														
5.0	10.5*	10.5*		10.3*														
6.0	10.5*	10.5*		10.3*														
7.0	10.5*	10.3*	8.6	10.3*														
8.0	10.5*	9.7*	8.2	10.3*	8.8		5.7			4.2								
9.0	10.5*	9.2*	7.8	10.3*	8.8		5.7			4.2			3.5					
10.0	10.5*	8.7	7.5	9.6*	8.8		5.7			4.2			3.5			2.4		
12.0	9.3*	7.9	7.1	7.2	8.1	7.8	5.7	5.7		4.2	4.2		3.5	3.5		2.4		
14.0	7.4	7.3	6.7	5.6	6.3	6.9	5.1	5.3	5.0	4.2	4.2	3.8	3.5	3.5		2.4	2.4	
16.0	5.8	6.0		4.3	4.9	5.4	4.0	4.6	4.6	4.1	4.0	3.5	3.5	3.4	3.1	2.4	2.4	2.4
18.0				3.2	3.7	4.1	3.1	3.6	4.0	3.2	3.7	3.4	3.3	3.2	2.9	2.4	2.4	2.4
20.0				2.3	2.8	3.1	2.4	2.8	3.2	2.5	3.0	3.2	2.6	3.0	2.8	2.4	2.4	2.4
22.0				1.7	2.0	2.3	1.7	2.2	2.5	1.9	2.3	2.6	2.0	2.4	2.6	1.9	2.3	2.4
24.0				1.1	1.5	1.7	1.2	1.6	1.9	1.4	1.8	2.1	1.5	1.9	2.2	1.5	1.8	2.1
26.0				0.7	1.0	1.1		1.1	1.3	1.0	1.3	1.6	1.1	1.4	1.7	1.1	1.4	1.6
28.0					0.5	0.7			0.9		0.9	1.1		1.0	1.3		1.0	1.2

* Mit Zusatzhubausrüstung / * With additional lifting equipment / * Avec équipement supplémentaire / * Con equipo adicional

m	11.1 m + 16.0 m			30.2 m + 16.0 m			41.7 m + 16.0 m			45.3 m + 16.0 m			49.1 m + 16.0 m			52.1 m + 16.0 m		
	0°	20°	40°	0°	20°	40°	0°	20°	40°	0°	20°	40°	0°	20°	40°	0°	20°	40°
2.5	7.9																	
3.0	7.9																	
3.5	7.9																	
4.0	7.9																	
4.5	7.9																	
5.0	7.9																	
6.0	7.9			5.2														
7.0	7.4			5.2														
8.0	7.0	5.6		5.2														
9.0	6.5	5.3		5.2			3.2			2.8								
10.0	6.1	5.0		5.2			3.2			2.8			2.4					
12.0	5.5	4.6	4.0	5.2	4.8		3.2			2.8			2.4			1.7		
14.0	4.9	4.2	3.8	5.2	4.5		3.2			2.8			2.4			1.7		
16.0	4.5	3.9	3.5	4.5	4.3	3.7	3.2	3.2		2.8	2.8		2.4			1.7		
18.0	4.1	3.6	3.4	3.6	4.1	3.5	3.2	3.2		2.8	2.8		2.4	2.4		1.7	1.7	
20.0	3.8	3.4	3.2	2.8	3.6	3.4	2.5	3.2	3.2	2.6	2.7	2.3	2.4	2.3		1.7	1.7	
22.0	3.5	3.3	3.2	2.1	2.8	3.3	1.9	2.7	3.2	2.0	2.5	2.2	2.0	2.2	1.9	1.7	1.7	1.7
24.0	3.1	3.2		1.6	2.2	2.8	1.5	2.1	2.7	1.5	2.2	2.1	1.6	2.1	1.8	1.5	1.7	1.7
26.0				1.1	1.6	2.2	1.1	1.6	2.1	1.1	1.7	2.0	1.2	1.7	1.8	1.1	1.7	1.7
28.0				0.7	1.2	1.6		1.2	1.7		1.3	1.7		1.4	1.7		1.3	1.6
30.0					0.8	1.2			1.2			1.3		1.0	1.4			1.3
32.0						0.8						1.0			1.1			

Tragfähigkeiten
Lifting capacities
Capacités de levage
Capacidades de elevación



m	11.1 m + 9.0 m			30.2 m + 9.0 m			41.7 m + 9.0 m			45.3 m + 9.0 m			49.1 m + 9.0 m			52.1 m + 9.0 m		
	0°	20°	40°	0°	20°	40°	0°	20°	40°	0°	20°	40°	0°	20°	40°	0°	20°	40°
2.5	10.5*																	
3.0	10.5*																	
3.5	10.5*																	
4.0	10.5*	10.5*																
4.5	10.5*	10.5*		10.3*														
5.0	10.5*	10.5*		10.3*														
6.0	10.5*	10.5*		10.3*														
7.0	10.5*	10.3*	8.6	10.3*														
8.0	10.5*	9.7*	8.2	10.3*	8.8		5.7			4.2								
9.0	10.5*	9.2*	7.8	10.3*	8.8		5.7			4.2			3.5					
10.0	10.5*	8.7	7.5	9.0*	8.8		5.7			4.2			3.5			2.4		
12.0	9.1*	7.9	7.1	6.7	7.6	7.8	5.7	5.7		4.2	4.2		3.5	3.5		2.4		
14.0	6.9	7.3	6.7	5.1	5.9	6.5	4.7	5.3	5.0	4.2	4.2	3.8	3.5	3.5		2.4	2.4	
16.0	5.4	5.6		3.9	4.5	5.1	3.6	4.2	4.6	3.7	4.0	3.5	3.5	3.4	3.1	2.4	2.4	2.4
18.0				2.9	3.4	3.8	2.7	3.3	3.7	2.9	3.4	3.4	3.0	3.2	2.9	2.4	2.4	2.4
20.0				2.0	2.5	2.8	2.1	2.5	2.9	2.2	2.7	3.0	2.3	2.7	2.8	2.2	2.4	2.4
22.0				1.4	1.8	2.1	1.5	1.9	2.2	1.7	2.1	2.4	1.8	2.1	2.5	1.7	2.1	2.4
24.0				0.9	1.2	1.4	1.0	1.3	1.6	1.2	1.6	1.8	1.3	1.6	1.9	1.2	1.6	1.9
26.0					0.7	0.9			1.1		1.1	1.4		1.2	1.5		1.2	1.4
28.0												0.9			1.1			1.0

* Mit Zusatzhubausrüstung / * With additional lifting equipment / * Avec équipement supplémentaire / * Con equipo adicional

m	11.1 m + 16.0 m			30.2 m + 16.0 m			41.7 m + 16.0 m			45.3 m + 16.0 m			49.1 m + 16.0 m			52.1 m + 16.0 m		
	0°	20°	40°	0°	20°	40°	0°	20°	40°	0°	20°	40°	0°	20°	40°	0°	20°	40°
2.5	7.9																	
3.0	7.9																	
3.5	7.9																	
4.0	7.9																	
4.5	7.9																	
5.0	7.9																	
6.0	7.9			5.2														
7.0	7.4			5.2														
8.0	7.0	5.6		5.2														
9.0	6.5	5.3		5.2			3.2			2.8								
10.0	6.1	5.0		5.2			3.2			2.8			2.4					
12.0	5.5	4.6	4.0	5.2	4.8		3.2			2.8			2.4			1.7		
14.0	4.9	4.2	3.8	5.2	4.5		3.2			2.8			2.4			1.7		
16.0	4.5	3.9	3.5	4.2	4.3	3.7	3.2	3.2		2.8	2.8		2.4			1.7		
18.0	4.1	3.6	3.4	3.3	4.1	3.5	2.9	3.2		2.8	2.8		2.4	2.4		1.7	1.7	
20.0	3.8	3.4	3.2	2.5	3.3	3.4	2.2	3.0	3.2	2.3	2.7	2.3	2.3	2.3		1.7	1.7	
22.0	3.4	3.3	3.2	1.8	2.6	3.3	1.7	2.4	3.1	1.7	2.4	2.2	1.8	2.2	1.9	1.7	1.7	1.7
24.0	2.8	3.0		1.3	1.9	2.5	1.2	1.9	2.4	1.3	1.9	2.1	1.3	2.0	1.8	1.3	1.7	1.7
26.0				0.9	1.4	1.9		1.4	1.9		1.5	2.0		1.5	1.8		1.5	1.7
28.0					1.0	1.4		1.0	1.5		1.1	1.5		1.2	1.6		1.1	1.5
30.0						1.0			1.1			1.1			1.2			1.2
32.0						0.6												

Hubhöhen
Lifting heights
Hauteurs de levage
Alturas de elevación

Tragfähigkeiten
Lifting capacities
Capacités de levage
Capacidades de elevación

16.5t **DIN/ISO/EN**

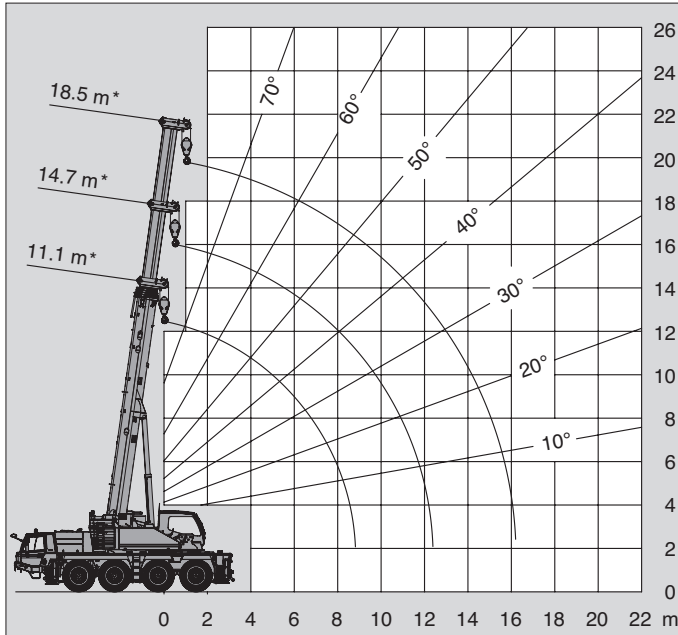

16.5t **DIN/ISO/EN**

↘ m	11.1 m*	14.7 m*	18.5 m*
3.0	19.6	20.1	17.4
3.5	17.8	18.3	16.2
4.0	16.2	16.7	15.1
4.5	14.9	15.4	14.2
5.0	13.7	14.2	13.3
6.0	11.7	12.2	11.9
7.0	9.4	10.1	10.6
8.0	7.6	8.3	8.7
9.0		6.9	7.3
10.0		5.8	6.2
12.0		4.1	4.6
14.0			3.4
16.0			2.6

* Oberwagenverriegelung eingelegt * Superstructure verrouillé
* Superstructure locked * Bloqueo de superestructura

12.2t **DIN/ISO/EN**

↘ m	11.1 m*	14.7 m*	18.5 m*
3.0	19.7	20.2	17.4
3.5	17.9	18.4	16.2
4.0	16.3	16.8	15.1
4.5	15.0	15.5	14.2
5.0	13.1	13.9	13.3
6.0	9.9	10.7	11.2
7.0	7.7	8.5	8.9
8.0	6.1	6.8	7.3
9.0		5.6	6.1
10.0		4.6	5.1
12.0		3.2	3.6
14.0			2.6
16.0			1.9

* Oberwagenverriegelung eingelegt * Superstructure verrouillé
* Superstructure locked * Bloqueo de superestructura

10.2t **DIN/ISO/EN**

↘ m	11.1 m*	14.7 m*	18.5 m*
3.0	19.8	20.2	17.4
3.5	17.9	18.4	16.2
4.0	16.4	16.5	15.1
4.5	14.0	14.6	14.1
5.0	12.0	12.8	12.7
6.0	9.0	9.8	10.3
7.0	7.0	7.7	8.2
8.0	5.5	6.2	6.6
9.0		5.0	5.5
10.0		4.1	4.6
12.0		2.8	3.2
14.0			2.3
16.0			1.6

* Oberwagenverriegelung eingelegt * Superstructure verrouillé
* Superstructure locked * Bloqueo de superestructura

4.4t **DIN/ISO/EN**

↘ m	11.1 m*	14.7 m*	18.5 m*
3.0	17.7	16.9	15.9
3.5	15.0	14.5	13.8
4.0	12.5	12.6	12.1
4.5	10.4	11.0	10.7
5.0	8.7	9.6	9.5
6.0	6.4	7.1	7.6
7.0	4.7	5.5	6.0
8.0	3.5	4.3	4.7
9.0		3.3	3.8
10.0		2.6	3.0
12.0		1.5	2.0
14.0			1.2
16.0			0.6

* Oberwagenverriegelung eingelegt * Superstructure verrouillé
* Superstructure locked * Bloqueo de superestructura

3.4t **DIN/ISO/EN**

↘ m	11.1 m*	14.7 m*	18.5 m*
3.0	16.8	16.0	15.1
3.5	14.1	13.7	13.1
4.0	11.8	11.9	11.5
4.5	9.7	10.4	10.1
5.0	8.2	9.0	9.0
6.0	5.9	6.7	7.2
7.0	4.3	5.1	5.6
8.0	3.2	3.9	4.4
9.0		3.0	3.5
10.0		2.3	2.8
12.0		1.3	1.7
14.0			1.0
16.0			0.5

* Oberwagenverriegelung eingelegt * Superstructure verrouillé
* Superstructure locked * Bloqueo de superestructura

Anmerkungen zu den Traglasttabellen
Remarks relating to the rating charts
Remarques relatives aux tableaux des charges
Notas relativas a los graficos de carga

DIN/ISO/EN
Anmerkungen zu den Traglasttabellen

Die Tragfähigkeiten im Festigkeitsbereich basieren auf DIN 15018 Blatt 2 und Blatt 3 und F.E.M.

Die Tragfähigkeiten im Standsicherheitsbereich entsprechen DIN 15019 Teil 2 / ISO 4305 / EN 13000.

In Abhängigkeit der Auslegerlänge sind bei den Traglasttabellen Windgeschwindigkeiten von 10 m/s bis max. 15 m/s zulässig. Aufgrund unterschiedlicher Ausfahrfolgen der Teleskope können die in den Traglasttabellen angegebenen Auslegerlängen geringfügig abweichend sein.

Die Tragfähigkeiten sind in metrischen Tonnen angegeben.

Das Gewicht des Lasthakens bzw. der Hakenflasche und weiterer Anschlagmittel ist von der Tragfähigkeit abzuziehen.

Die Tragfähigkeiten für den Teleskopausleger gelten nur bei demonstrierter Auslegerverlängerung.

Die Ausladung ist der horizontale Abstand von Mitte Drehkranz bis Mitte freihängender, nicht schwingender Last.

Tragfähigkeitsänderungen vorbehalten.

Obige Angaben dienen nur zur Information. Die Bedienungsanleitungen müssen zu Rate gezogen werden, bevor die Maschine in Betrieb genommen wird. Alle hier gemachten Angaben beziehen sich auf die Standard-Ausführung. Jegliche Ausrüstungsveränderungen können die angegebenen Werte beeinflussen.

Remarks relating to the capacity charts

The lifting capacities in the structural area are based on DIN 15018 parts 2 and 3 and F.E.M.

The lifting capacities in the stability area are based on DIN 15019 part 2 / ISO 4305 / EN 13000.

Maximum admissible wind velocity for working with telescopic boom is 15 m/sec to 10 m/sec depending at boom length and for working with fly jib 10 m/sec. Due to the different extension sequences of the various telescopes, the boom lengths may differ slightly from those indicated in the lifting capacity charts.

The lifting capacities are shown in metric tons.

The weight of load handling devices such as hook blocks, slings, etc., must be considered as part of the load and must be deducted from the lifting capacities.

The lifting capacities for the telescopic boom apply to a crane with no boom extensions being stowed or mounted on the crane.

The working radius is the horizontal distance from the centre of rotation to the centre of the freely suspended non-oscillating load.

The lifting capacities are subject to change without prior notice.

The above remarks are for basic information only and the operator's manual must be consulted before operating this crane. All data and performances refer to the standard crane. The addition of optional and other equipment may affect the performance of the crane.

Remarques relatives aux tableaux des charges

Les forces de levage sont conformes aux normes DIN 15018, p. 2 et 3, et F.E.M.

Les forces de levage dans la partie de stabilité au renversement sont conformes aux normes DIN 15019, chap. 2 / ISO 4305 / EN 13000.

Des vitesses de vent sont admissibles entre 10 m/s jusqu'à max 15 m/s en fonction de la longueur de flèche. A cause des séquences d'extension différentes des télescopes individuels, les longueurs de flèche peuvent varier légèrement par rapport aux valeurs indiquées dans les tableaux de charge.

Les forces de levage sont données en tonnes métriques.

Le poids du crochet-moufle et de tous les accessoires d'élingage font partie de la charge et sont à déduire des charges indiquées.

Les forces de levage indiquées pour la flèche télescopique s'entendent fléchette déposée.

Comme portée, on entend la distance horizontale du centre de la couronne de rotation au centre de la charge librement suspendue et non oscillante.

Sauf modification de forces de levage.

Les données ci-dessus servent à titre d'information. Avant la mise en marche de la grue il est conseillé d'étudier les instructions de service. Toutes les données indiquées ci-dessus se réfèrent à la machine de base. Tout changement de l'équipement de la grue peut influencer ces valeurs.

Notas relativas a los graficos de carga

En cuanto a los datos referentes a resistencia, las capacidades de carga están basados sobre las normas DIN 15018, pág. 2 y 3, y F.E.M.

En cuanto a los datos referentes a estabilidad anti-vuelco, las capacidades de carga están basados sobre las normas DIN 15019, Cap. 2 / ISO 4305 / EN 13000.

En independencia a la longitud de la pluma, están toleradas velocidades de viento de entre 10 m/s y 15 m/s. Debido a las diferentes secuencias de extensión de los telescopios, puede haber algunas variaciones insignificantes con respecto a las longitudes de pluma indicadas en las tablas de carga.

Las capacidades de carga indicadas en las tablas corresponden a toneladas métricas.

Hay que deducir los pesos del gancho, eslingas y de otros dispositivos para fijación de cargas de los valores indicados en las tablas.

Las capacidades de carga referentes a la pluma telescópica valen solamente si el plumín está desmontada.

Como alcance se entiende la distancia horizontal desde el centro de la corona de giro hasta el centro de la carga suspendida libremente y no oscilante.

Salvo modificación de capacidades de carga, sin previo aviso.

Los datos arriba indicados sirven solamente para su información. Hay que leer las instrucciones para el uso antes de la puesta en servicio de la máquina. Todos los datos mencionados en las presentes tablas rigen para los modelos standard. Cualquier modificación del equipo montado puede dar lugar a modificaciones de aquellos valores.

Gegengewichtvarianten
Counterweight versions
Variations des contrepoids
Variaciones de contrapeso

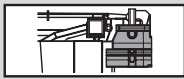
 Gegengewicht / Counterweight Contrepoids / Contrapeso	1 x	1 x	2 x	1 x	2 x	1 x	2 x	1 x
	①	②	③	④	⑤	⑥	⑦	⑧
(t)	0.3	0.5	0.8	1.0	2.3	3.5	2.0	1.0

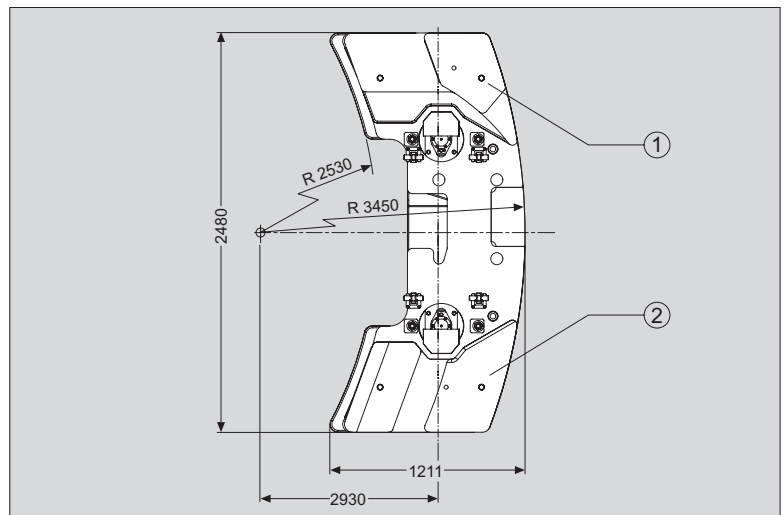
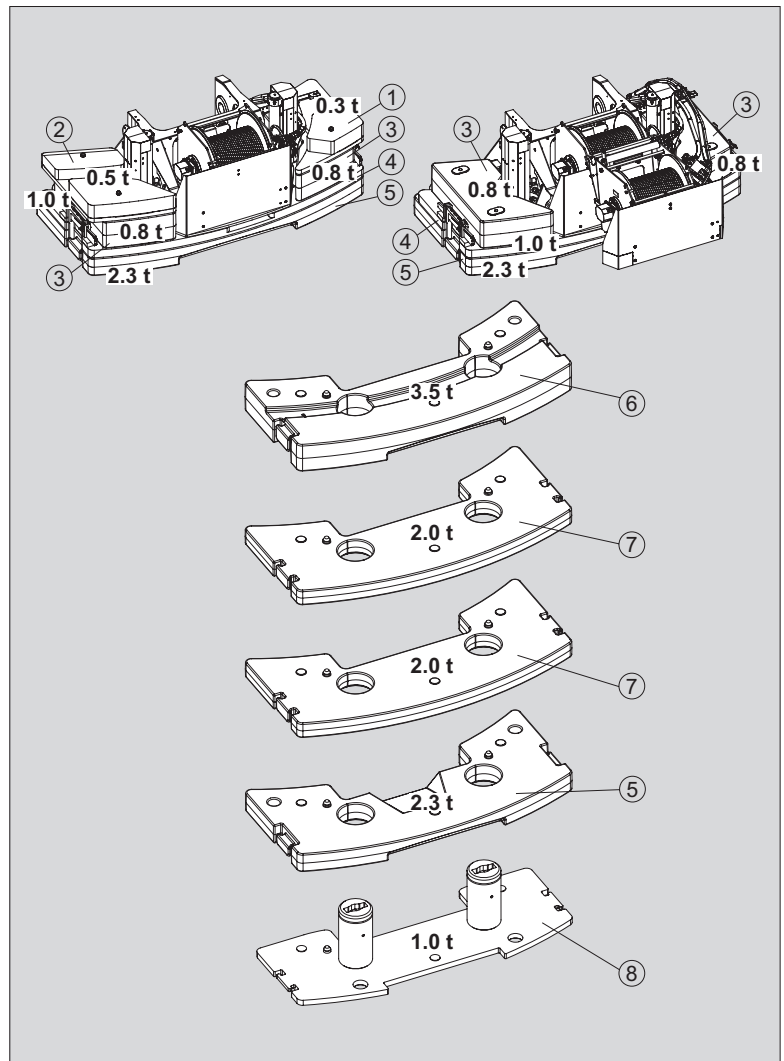
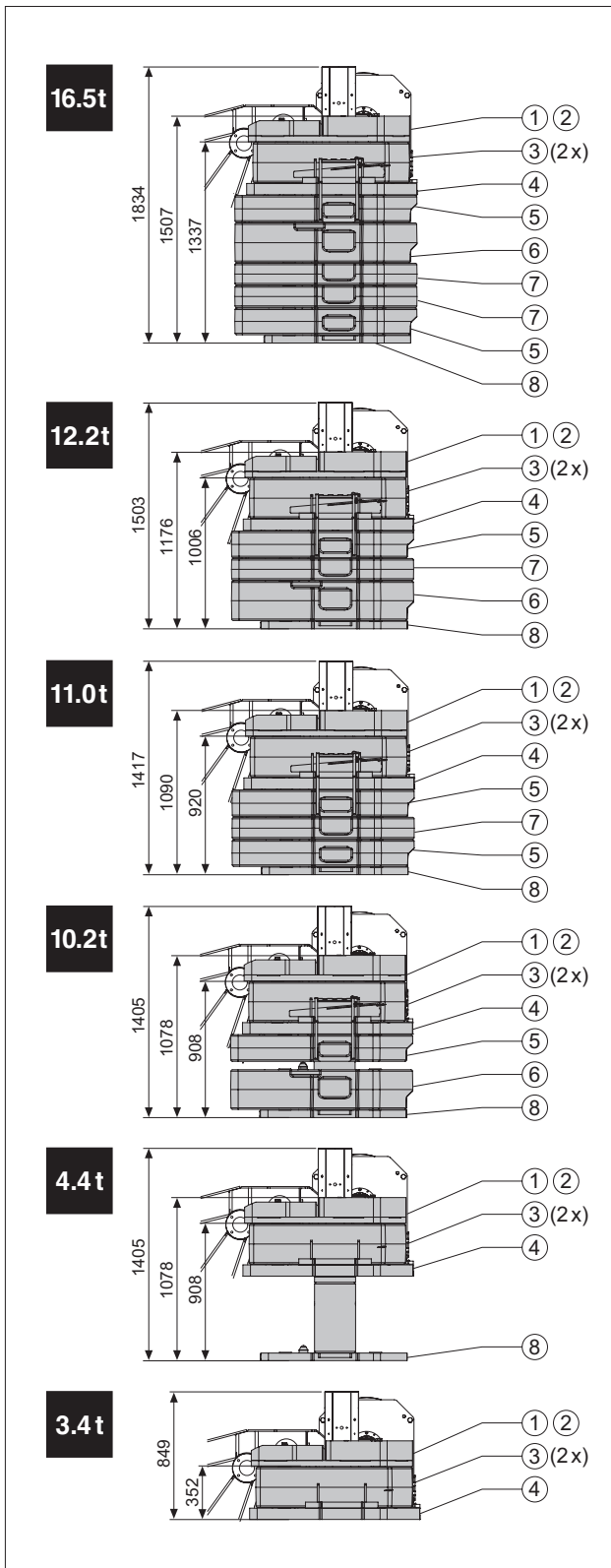

Ausrüstung

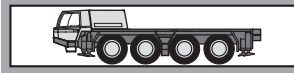

Rahmen Verwindungs- und biegesteife Schweißkonstruktion aus hochfestem Feinkornstahl. Zentralschmieranlage.

Abstützung 4-Punkt-Abstützung, hydraulisch, Bedienungsmöglichkeiten an beiden Seiten des Fahrgestelles und in der Oberwagenkabine.
Abstützbasis 6,4 m (und 4,4 m) x 7,9 m.

Motor Mercedes-Benz 6-Zylinder-Dieselmotor OM 470LA, (Euromot IV / EPA Tier 4f), wassergekühlt, Leistung 320 kW (435 PS) bei 1700 min⁻¹. Drehmoment 2100 Nm (214 kpm) bei 1300 min⁻¹. Motorleistung nach ECE R 120.
Kraftstoffbehälter 400 l. AdBlue-Behälter: 40 l.

Getriebe ZF-AS-Tronic 2531 mechanisches Schaltgetriebe mit elektronisch-pneumatisch betätigter Trockenkupplung und vollautomatischer Schaltung mit 12 Vorwärts- und 2 Rückwärtsgängen.

Verteilergetriebe 2-stufiges Verteilergetriebe.

Antrieb 8 x 6 (8 x 8 Option).

Achsen

1. Achse: gelenkt, nicht angetrieben.
2. Achse: gelenkt, angetrieben, Differentialsperre quer.
3. Achse: gelenkt, angetrieben, Differentialsperre längs und quer.
4. Achse: gelenkt, angetrieben, Differentialsperre quer.

Achsaufhängung Hydropneumatische Federung mit Niveauregulierung.

Bremsen Druckluft-Zweikreis-Scheibenbremsanlage mit ABS System. Feststellbremse als Federspeicherbremse an der 2., 3. und 4. Achse wirkend. Intarder und Motorbremse als Dauerbremse.

Räder 8-fach 385/95 R 25 (14.00 R 25), (Breite 2,55 m).

Lenkung ZF-Servocom-Zweikreis-Hydraulenlenkung. Mechanische Lenkung der 1. und 2. Achse und Mitlenken der 4. Achse bis zu einer Geschwindigkeit von 25 km/h, hydraulisch unterstützt, mit Notlenkpumpe. Lenkung aller Achsen möglich. Hydrostatische Lenkung aller Achsen aus der Oberwagenkabine.

Unterwagenkabine Zwei-Mann-Frontfahrerhaus in Stahl-Kunststoff-Verbund-Konstruktion, Sicherheitsverglasung, luftgedeperte Sitze (Fahrersitz mit Heizung) und motorabhängige Wasserheizung, Radio / CD-Player, Kontroll- und Bedienungselemente für den Fahrbetrieb. Tempomat/ Bremsomat-Funktion.

Elektrische Anlage 24 Volt-Gleichstrom, 2 Batterien, Abstützfeldbeleuchtung.
Die elektrische Anlage entspricht der EG-Norm.

Zusatzrüstung (gegen Mehrpreis)
Anhängerkupplung, motorunabhängige Zusatzheizung mit Motorvorwärmung, Klimaanlage, 8 x 8 Antrieb, 445/ 95 R 25 (16.00 R 25), 525/80 R 25 (20.5 R 25) Bereifung, Reserverad, Sonderlackierung und Beschriftung.
Weitere Zusatzrüstung auf Anfrage.

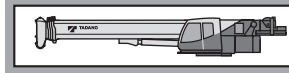

Rahmen Verwindungssteife Schweißkonstruktion mit einer außenverzahnten, einreihigen Kugeldrehverbindung, um 360° unbegrenzt drehbar. Zentralschmieranlage.

Motor Mercedes-Benz 4-Zylinder-Dieselmotor OM 934 LA (Euromot IV / EPA Tier 4f), wassergekühlt. Drehzahl über Fußpedal stufenlos regelbar, Leistung 129 kW (175 PS) bei 2200 min⁻¹. Drehmoment 750 Nm (77 kpm) bei 1200 - 1600 min⁻¹. Motorleistung nach ECE R 120.
Kraftstoffbehälter 220 l. AdBlue-Behälter: 10 l.

Hydraulik System Diesel-hydraulisch mit 3-Kreis-Hydraulik, 1 leistungsgeregelte Axialkolbendoppelpumpe (hydraulisch verstellbar) und 1 Zahnrad-Doppelpumpe, Ölkühler.

Steuerung Zwei 4-fach Kreuzsteuerhebel mit elektrischer Vorsteuerung.

Teleskopausleger Sechsteiliger Teleskopausleger aus hochfestem Feinkornstahl, bestehend aus einem Grundaussleger und 5 Teleskopteilen, 1 Teleskopzylinder, hydraulisch unter Teillast teleskopierbar. 11,1 m - 52,1 m lang.
Rollenkopf mit 6 Seilrollen.

Wippwerk Ein Differentialzylinder mit angebautem Senkbremsventil.

Hubwerk Axialkolben-Motor, Hubwerkstrommel mit eingebautem Planetengetriebe und federbelasteter Hydro-Lamellenbremse mit integriertem Freilauf beim Heben.
Hubseil mit 'Super-Stop' Einrichtung.

Drehwerk Axialkolben-Motor, zweistufiges Planetengetriebe mit fußbetätigter Betriebsbremse und Feststellung.
Drehgeschwindigkeit stufenlos von 0 - 2 min⁻¹.

Gegengewicht Standard 11,0 t teilbar.
Die Bedienung erfolgt aus der Oberwagenkabine.

Oberwagenkabine Großräumige Krankabine in Stahl-Kunststoff-Ausführung mit Sicherheitsverglasung und getönten Scheiben, kippbarem Arbeitsplatz mit verstellbarem, hydraulisch gedämpftem Fahrersitz mit Heizung, motorunabhängige Heizung mit Motorvorwärmung, Klimaanlage, Radio / CD-Player, Kontroll- und Bedienungselemente für Kranbetrieb, Abstützbetätigung und Verfahrbarkeit vom Oberwagen.

Elektrische Anlage 24 Volt-Gleichstrom, 2 Batterien.

Sicherheitseinrichtungen Lastmomentbegrenzung (LMB), Arbeitsbereichsbegrenzung, Hubendschalter, Windenendschalter, Seilwindendrehmelder, Sicherheitsventile gegen Rohr- und Schlauchbrüche. Sperrventile an Hydraulik-Zylindern.

Zusatzrüstung (gegen Mehrpreis)
'Lift Adjuster', Auslegerverlängerung 9,0 m / 16,0 m wahlweise abwinkelbar 0°, 20° und 40° oder hydraulisch 0°- 40°, Schwerlastspitze 1,6 m, Zusatzgegengewicht 5,5 t, verschiedene Unterflaschen, 2. Hubwerk (wie Hauptwinde), Drehbereichsbegrenzung, Zusatzölkühler, Sonderlackierung und Beschriftung.
Weitere Zusatzrüstung auf Anfrage.

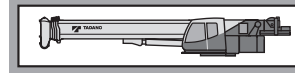
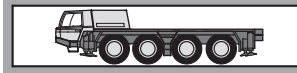

Frame Torsion-resistant, welded construction made from high strength, fine-grained steel. Central lubricating system.

Outriggers 4 point, telescopic hydraulic outriggers with controls on both sides of carrier and in superstructure cab. Outrigger base 6.4 m (4.4 m mid extension) x 7.9 m.

Carrier engine Mercedes-Benz 6 cylinder model OM 934 LA (Euromot IV / EPA Tier 4f), water-cooled diesel engine. Rated at 320 kW (435 HP) at 1700 min⁻¹. Torque 2100 Nm (214 kpm) at 1300 min⁻¹. Engine rating according to ECE R 120. Fuel tank 400 l. AdBlue-tank: 40 l.

Transmission ZF-AS-Tronic 2531 mechanical transmission with electro-pneumatically operated dry-type clutch and automatic gear shifting with 12 forward gears and 2 reverse gears.

Transfer Case Two stage.

Drive 8 x 6 (8 x 8 option).

Axles

- 1st axle: steered, not driven.
- 2nd axle: steered, driven, with differential lock, transverse.
- 3rd axle: steered, driven, with differential locks longitudinal and transverse.
- 4th axle: steered, driven, with differential lock, transverse.

Suspension Hydro-pneumatic with levelling adjustment.

Brake system Service disk brakes: dual circuit compressed airsystem. Parking brake: spring loaded type acting on 2nd, 3rd and 4th axles. Auxiliary brakes: Intarder and engine brake.

Tyres (8) 385/95 R 25 (14.00 R 25), (width 2.55 m).

Steering system ZF-Servocom, dual circuit hydraulic steering with emergency steering pump, mechanical hydraulically assisted steering of front two axles and automatic steering of the 4th axle up to a travel speed of 25 km/h. Steering of all axles possible. All axles steered hydrostatically from superstructure cab.

Carrier cab Two man full width cab of composite (steel sheet metal and fibre-glass) structure, with safety glass, air-cushioned adjustable seats (drivers seat with heater) and engine dependent water heater, radio / CD-player, complete controls and instrumentation for road travel. Cruise control with hill braking feature functions.

Electrical system 24 volt DC system, 2 batteries, outrigger area lighting. Electrical system conforms with EEC regulations.

Optional Equipment (at extra charge)

Towing attachment, engine independent additional heater with engine pre-heat, air conditioning, 8 x 8 drive, 445 / 95 R 25 (16.00 R 25), 525 / 80 R 25 (20.5 R 25) tyres, spare wheel and tyre, special painting and lettering.

Further optional equipment available upon request.

Frame Torsion-resistant, all-welded structure of high strength steel. Connected to carrier by single-row, ball-bearing slewing ring with external gearing for 360° continuous rotation. Central lubricating system.

Superstructure engine Mercedes-Benz 4 cylinder model OM 934 LA (Euromot IV / EPA Tier 4f), water cooled diesel engine. RPM infinitely variable via foot pedal, rating 129 kW (175 HP) at 2200 min⁻¹. Torque 750 Nm (77 kpm) at 1200 - 1600 min⁻¹. Engine rating according to ECE R 120. Fuel tank 220 l. AdBlue-tank: 10 l.

Hydraulic system Three circuit diesel hydraulic system with 1 power controlled axial piston double pump (hydraulically adjustable) and 1 double gear pump, oil cooler.

Controls Electrical, 2 joy-stick levers for simultaneous operation of crane motions.

Telescopic boom 6 sections, made of high tensile, fine-grained steel, consisting of 1 base section and 5 telescoping sections extended by means of a single telescopic cylinder. All telescope sections extendable under partial load. 11.1 m to 52.1 m long. Boom head with 6 sheaves.

Derricking system 1 double acting hydraulic cylinder with integral brake and holding valve.

Main winch Axial piston motor, winch drum with integrated planetary reduction and hydraulically controlled spring-loaded multiple disc brake and integrated free rotation (no sagging of load when hoisting). Hoist cable with 'Super-Stop' easy reeving system.

Slewing system Axial piston motor with two-stage planetary reduction with a foot actuated service and a parking brake. Speed infinitely variable 0 - 2 min⁻¹.

Counterweight Standard 11.0 t divisible, assembled and disassembled by hydraulic cylinders controlled from superstructure cab.

Superstructure cab Spacious panoramic cab of composite structure with safety (tinted) glass windows, tiltable cockpit with hydraulically cushioned adjustable seat with heater, engine independent heater with engine pre-heat, air conditioning, radio / CD-player, complete controls and instrumentation for crane operation, on-site travelling and outriggers.

Electrical system 24 volt DC system, 2 batteries.

Safety devices Load moment device (LMD), working area limiter, hoist limit switch, lower limit switch and drum turn indicator, safety valves against pipe and hose rupture. Holding valves on hydraulic cylinders.

Optional Equipment (at extra charge)

'Lift Adjuster', boom extension 9.0 m / 16.0 m offsets 0°, 20° and 40° or hydraulically 0°- 40°, heavy duty jib 1.6 m, additional counterweight 5.5 t, selection of hook blocks, auxiliary winch (same as main winch), slewing area limitation, additional oil cooler, special painting and lettering.

Further optional equipment available upon request.

Équipement

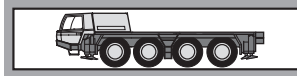

Châssis Construction mécanosoudée, en acier à grain fin très rigide, résistant aux flexions et aux torsions. Graissage centralisé.

Calage Dispositif de calage horizontal et vertical en 4 points, entièrement déployable hydrauliquement. Commande des mouvements sur les deux côtés du porteur et depuis la cabine de la superstructure. Calage 6,4 m (aussi 4,4 m) x 7,9 m.

Moteur Mercedes-Benz diesel 6 cylindres, modèle OM 470LA, (Euromot IV / EPA Tier 4f), refroidi par eau, de 320 kW (435 CV) à 1700 min⁻¹. Couple: 2100 Nm (214 kpm) à 1300 min⁻¹. Puissance selon ECE R 120. Capacité du réservoir 400 l. AdBlue-capacité du réservoir 40 l.

Boîte de vitesse Boîte mécanique ZF-AS-Tronic, modèle 12 AS 2531 avec embrayage électro-pneumatique réglé à commande et boîte automatique, 12 vitesses AV et 2 vitesses AR.

Boîte de transfert À 2 gammes.

Entraînement 8 x 6 (8 x 8 option).

Essieux

1^{er} essieu: directeur, non entraîné.

2^{ème} essieu: directeur, entraîné, blocage de différentiel transversal.

3^{ème} essieu: directeur, entraîné, blocage de différentiel longitudinal et transversal.

4^{ème} essieu: directeur, entraîné, blocage de différentiel transversal.

Suspension Hydro-pneumatique, avec réglage de niveau.

Freins Système de frein à disques, à air comprimé, à double circuit avec système ABS. Frein de stationnement: avec accumulateurs à ressort agissant sur le 2^{ème}, 3^{ème} et 4^{ème} essieu. Intarder et frein moteur conçu comme, frein continu.

Pneus 8 x 385/95 R 25 (14.00 R 25), (largeur 2,55 m).

Direction Servocom à double circuit, marque ZF. Direction mécanique du 1^{er} et 2^{ème} essieu, direction à assistance hydraulique du 4^{ème} essieu jusqu'à une vitesse de 25 km/h, avec pompe de secours pour direction. Direction de tous les essieux possible. Direction hydro-statique de tous les essieux depuis la cabine du grutier.

Cabine Cabine bi-place, construction en matière composite fibre de verre et acier. Vitrage en verre de sécurité, siège conducteur chauffant suspendu hydrauliquement. Chauffage à eau chaude relié au moteur, radio / CD-player. Organes de contrôle et de commande pour la conduite. Régulateur de vitesse, système automatique de freinage.

Système électrique 24 V courant continu, 2 batteries, éclairage des points de calage. Conforme aux normes CE.

Équipement supplémentaire (avec supplément de prix) Attache-remorque, chauffage auxiliaire indépendant du moteur avec préchauffage du moteur, climatisation, Entraînement 8 x 8, pneus 445/95 R 25 (16.00 R 25), 525/80 R 25 (20.5 R 25), roue de secours, peinture spéciale et inscription. Autres équipements supplémentaires sur demande.

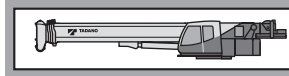

Plate forme Construction mécano-soudée résistante à la torsion. Couronne d'orientation à billes à une rangée, à denture extérieure, permettant une rotation illimitée sur 360°. Graissage centralisé.

Moteur Mercedes-Benz diesel 4 cylindres, modèle OM 934 LA (Euromot IV / EPA Tier 4f), refroidi par eau, Réglage du nombre de tours par pédale, de 129 kW (175 CV) à 2200 min⁻¹. Couple: 750 Nm (77 kpm) à 1200 - 1600 min⁻¹. Puissance selon ECE R 120. Capacité du réservoir 220 l. AdBlue-capacité du réservoir 10 l.

Système hydraulique Diesel-hydraulique à 3 circuits, 1 double pompe à pistons axiaux à régulation de puissance (à réglage hydraulique) et 1 pompe à engrenages, refroidisseur d'huile.

Commande 2 manipulateurs à commande en croix (4 sens), assistés électriquement.

Flèche télescopique 1 flèche de base et 5 éléments télescopiques en acier fin, 1 vérin télescopique, hydrauliquement télescopable avec charge partielle. Longueur 11,1 m à 52,1 m. Tête de flèche avec 6 poulies.

Mécanisme de relevage 1 vérin différentiel muni de clapet de freinage de descente.

Mécanisme de levage Moteur hydraulique, tambour de levage avec boîte planétaire incorporée, frein d'arrêt à disques multiples à ressort, libéré lors du levage. Câble de levage avec dispositif 'Super-Stop'.

Orientation Moteur hydraulique avec entraînement planétaire à 2 gammes. Frein de service actionné par l'intermédiaire d'une pédale et frein de stationnement. Vitesse de rotation 0 à 2 min⁻¹ en continu.

Contrepoids Standard 11,0 t divisible, commandé depuis la cabine du grutier.

Cabine du grutier Cabine de grue spacieuse, construction en matière combinée acier / synthétique, avec vitrage de sécurité en verre teinté, siège chauffant, réglable et amorti hydrauliquement, inclinable avec instruments de commande, chauffage auxiliaire avec préchauffage du moteur, climatisation, radio / CD-player, éléments de commande et de contrôle pour travaux sur chantier, conduite et calage de la grue depuis la cabine du grutier.

Système électrique 24 V courant continu, 2 batteries.

Dispositifs de sécurité Limiteur de charge (CEC), limitation de zone de travail, interrupteur de fin de course de levage et de treuil, indicateur du nombre de tours, soupapes de sécurité contre ruptures des conduites et flexibles, clapets sur verins hydrauliques.

Équipement supplémentaire (avec supplément de prix) 'Lift Adjuster', fléchette 9,0 m / 16,0 m au choix inclinable 0°, 20° et 40° ou hydrauliquement 0° à 40°, fléchette pour levage lourde 1,6 m, contrepoids additionnel de 5,5 t, sélection de mouffles, 2^{ème} treuil de levage (identique au treuil principale), limitation de rotation, refroidisseur d'huile supplémentaire, peinture spéciale et inscription.

Autres équipements supplémentaires sur demande.

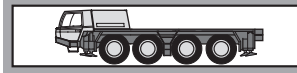

Chasis portante Construcción de acero de alta resistencia soldado, resistente a la torsión y a la flexión. Sistema de engrase central.

Estabilizadores Estabilizadores hidráulicos de 4 puntos. Posibilidad de manejo desde ambos lados del chasis portante y desde la cabina de la grúa. Extensión de los estabilizadores: 6,4 m (y 4,4 m) x 7,9 m.

Motor Mercedes-Benz modelo OM 470LA, (Euromot IV / EPA Tier 4f), 6 cilindros, diesel, refrigerado por agua. Nominal 320 kW (435 CV) a 1700 min⁻¹. Par 2100 Nm (214 kpm) a 1300 min⁻¹. Potencia del motor según ECE R 120. Depósito de combustible de 400 l. Depósito AdBlue 40 l.

Transmisión Transmisión mecánica tipo ZF-AS Tronic modelo 12 AS 2531 con accionamiento electro - neumáticamente embrague en seco y cambio automático 12 marchas delanteras y 2 marchas traseras.

Transmisión Caja de distribución (transfer) con 2 relaciones de velocidad.

Tracción 8 x 6 (8 x 8 opción).

Ejes

- 1º eje: de dirección, no accionado.
- 2º eje: de dirección, accionado, con bloqueo diferencial transversal.
- 3º eje: de dirección, accionado, con bloqueo diferencial transversal y longitudinal.
- 4º eje: de dirección, accionado, con bloqueo diferencial transversal.

Suspensión Suspensión hidroneumática con regulación de nivel.

Sistemas de frenos Sistema de frenos de disco neumático de doble circuito con Sistema anti bloqueo ABS. Freno de estacionamiento del tipo freno de muelle, accionando sobre los ejes 2º, 3º y 4º. Intarder y freno motor como freno continuo.

Neumáticos 8 x 385/95 R 25 (14.00 R 25), (ancho 2,55 m).

Dirección Hidráulica ZF Servocom de doble circuito. Dirección mecánica al 1º y 2º eje y direccional al 4º eje hasta una velocidad de 25 km/h. Bomba hidráulica de emergencia accionada por la transmisión. Dirección a todos los ejes. Desde la cabina de la superestructura: dirección hidrostática a ambos ejes.

Cabina Cabina para dos personas, en construcción de acero y fibra de vidrio. Cristales de seguridad, asiento con suspensión neumática, asiento de conductor calefactado. Calefacción por agua caliente del motor, radio / CD-player. Elementos de control y manejo para circular por carretera. Regulador de velocidad, sistema automático de frenado.

Sistema eléctrico Sistema de 24 V c.c. con dos baterías, faros de trabajo en los estabilizadores. El sistema eléctrico cumple la normativa CEE.

Equipo adicional (con suplemento de precio)
 Embrague de remolque, calefacción adicional con precalefacción del motor, climatización, Tracción 8 x 8, neumáticos 445/95 R 25 (16.00 R 25), 525/80 R 25 (20.5 R 25), rueda de repuesto, pintura especial e rotulación.
 Otros equipamientos sobre pedido.

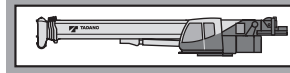

Superestructura Construida en aceros soldados, resistente a la torsión. Corona de giro con rodamiento de una fila de bolas con dientes externos para giro continuo de 360°. Sistema de engrase central.

Motor Mercedes-Benz modelo OM 934 LA (Euromot IV / EPA Tier 4f), 4 cilindros, diesel, refrigerado por agua. Las revoluciones aumentan de forma gradual accionado el acelerador. Nominal 129 kW (175 CV) a 2200 min⁻¹. Par 750 Nm (77 kpm) a 1200 - 1600 min⁻¹. Potencia del motor según ECE R 120. Depósito de combustible de 220 l. Depósito AdBlue 10 l.

Sistema hidráulico Sistema hidráulico de 3 circuitos, 1 bomba doble de pistones axiales de caudal variable (regulable hidráulicamente) y una bomba de engranajes, enfriador de aceite.

Mandos 2 palancas de control de tipo joy-stick para movimientos simultáneos de la grúa (4 direcciones), asistidos eléctricamente.

Pluma telescópica 6 secciones, un tramo base y 5 telescópicos de acero de alta resistencia soldado, 1 cilindro hidráulico, los tramos se pueden telescopar hidráulicamente bajo carga. Longitud de 11,1 m a 52,1 m. Cabeza de pluma con 5 poleas.

Elevación de pluma Mediante un cilindro hidráulico de doble efecto con válvula de retención integrada.

Cabrestante principal Motor hidráulico de pistones axiales y caudal fijo. Tambor del cabrestante con reducción planetaria y frenos de disco múltiples accionado, con sistema libre de elevación. Cable de elevación con sistema fácil de guiado y 'Super-Stop'.

Sistema de giro Motor hidráulico de pistones axiales con reducción planetaria de dos etapas. Freno de servicio controlado por pedal y freno de estacionamiento. Velocidad de giro variable de 0 a 2 min⁻¹.

Contrapeso El estándar 11,0 t divisible, se acciona desde la cabina de la grúa.













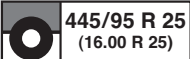

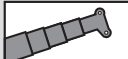
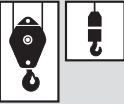
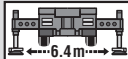





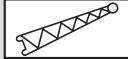

Cabina de la grúa Cabina espaciosa y confortable, en construcción de acero y fibra de vidrio, con cristales tintados de seguridad. Asiento de operador regulable amortiguado hidráulicamente, inclinable junto con los instrumentos y mandos, asiento calefactado. Calefacción independiente del motor y precalefacción del motor, climatización, radio / CD-player. Elementos de control y mando para el manejo de la grúa y para el desplazamiento en obra. Mandos para nivelación y extensión de los estabilizadores.

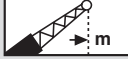
Sistema eléctrico Sistema de 24 V c.c. con dos baterías.

Medidas de seguridad Limitación del momento de carga (LMC), limitación del área de trabajo, interruptor de final de elevación, interruptor de 3 últimas vueltas en cabrestante, indicador de bajada o subida del cable del cabrestante, válvulas de seguridad para rotura de tubos y latiguillos. Válvulas de retención en los cilindros hidráulicos.

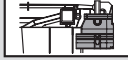
Equipo adicional (con suplemento de precio)
 'Lift Adjuster', plumín de 9,0 m / 16,0 m regulable de 0°, 20° y 40° (o hidráulicamente 0° a 40°), plumín de carga pesada de 1,6 m, contrapeso adicional de 5,5 t, selección de ganchos, 2º cabrestante, (similar a cabrestante principal), limitador de giro, enfriador adicional, pintura especial e rotulación.
 Otros equipamientos sobre pedido.

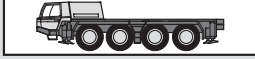
Symbolerklärung
 Symbols
 Glossaire des symboles
 Glosario de símbolos

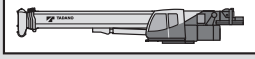
	<p>Siehe Seite 16 As on Page 16 Voyez la page 16 Véase la pagina 16</p>		<p>Wippwerk Derricking system Mécanisme de relevage Elevación de pluma</p>
	<p>Räder / Größe Tyres / Size Pneus / Largeur Neumáticos / Tamano de ruedas</p>		<p>Teleskopieren Boom telescoping Télescopage de flèche Telescopaje de pluma</p>
	<p>Achslast Axle load Charge à l'essieu Carga por eje</p>		<p>Teleskopausleger Telescopic boom Flèche télescopique Pluma telescópica</p>
	<p>Unterflasche / Hakengeschirr Hook block / Swivel hook Moufle / Elingues Gancho / Gancho de bola</p>		<p>Abstützung Outriggers Calage Estabilizadores</p>
	<p>Geschwindigkeiten Unterwagen Carrier speeds Vitesses du châssis Velocidades del chasis</p>		<p>Gegengewicht Counterweight Contrepoids Contrapeso</p>
	<p>Getriebe / Gang Transmission / Gear Boîte de vitesse / Rapport Transmisión / Marchas</p>		<p>Ausladung Radius Portée Radio</p>
	<p>Steigfähigkeit Gradeability Abtitude en pente Superacion de pendientes</p>		<p>Auslegerverlängerung Boom extension Fléchette Plumín</p>
	<p>Gelände Off road Tout-terrain Todo terreno</p>		<p>Auslegerverlängerung hydraulisch Boom extension hydraulically Fléchette hydrauliquement Plumín hidráulicamente</p>
	<p>Straße On road En route En carretera</p>		<p>Ausladung Radius Portée Radio</p>
	<p>Geschwindigkeiten Oberwagen Superstructure speeds Vitesses du partie tournante Velocidades de la superestructura</p>		<p>Nach hinten Over rear A l'arrière Sobre la parte trasera</p>
	<p>Hubwerk Main winch Mécanisme de levage Cabrestante principal</p>		<p>Gegengewichtvarianten Counterweight versions Variations des contrepoids Variaciones de contrapeso</p>
	<p>2. Hubwerk Auxiliary winch 2^{ème} treuil de levage 2^o cabrestante</p>		<p>Unterwagen Carrier Châssis Chasis</p>
	<p>Drehwerk / hydraulisch verriegelt Slewning system / hydraulically locked Orientation / hydrauliquement verrouillé Sistema de giro / Embulonamiento hidráulico</p>		<p>Oberwagen Superstructure Partie tournante Superestructura</p>



A large grid area for taking notes, consisting of a grey background with a white grid pattern.



TADANO FAUN GmbH

Faunberg 2, 91207 Lauf a. d. Pegnitz, Germany
Phone: +49-9123-185-0 Fax: +49-9123-3085
<http://www.tadanofaun.de> E-mail: info@tadanofaun.de

TADANO LTD. (International Division)

4-12, Kamezawa 2-chome, Sumida-ku Tokyo 130-0014, Japan
Phone: 81-3-3621-7750 Fax: 81-3-3621-7785
<http://www.tadano-global.com> E-mail: tdnihq@tadano.co.jp